



A201 User Manual

Software Version: 2.1246.4

Release Date: 2024/9/19



Directory

Directory	1
1 Picture	3
2 Table	5
3 Safety Instruction	6
4 Overview	7
5 Install Guide	8
5.1 Use POE or External Power Adapter	8
6 User Guide	9
6.1 Interface Description	9
6.2 Installation Instructions	10
6.2.1 Device IP Address	10
6.3 WEB Configuration	11
6.4 SIP Configurations	12
6.5 Volume Setting	12
7 Basic Function	14
7.1 Making Calls	14
7.2 Answering Calls	14
7.3 End of the Call	14
7.4 Auto Answer	14
7.5 Call Waiting	16
8 Advance Function	17
8.1 Intercom	17
8.2 MCAST	17
8.3 Hotspot	19
9 Web Configurations	21
9.1 Web Page Authentication	21
9.2 System >> Information	21
9.3 System >> Account	22
9.4 System >> Configurations	22
9.5 System >> Upgrade	23
9.6 System >> Auto Provision	25
9.7 System >> Tools	28
9.8 System>>Reboot	29
9.9 Network >> Basic	29

9.10 Network >> Service Port	31
9.11 Network>>VPN	32
9.12 Network >> Advanced	34
9.13 Line>> SIP	35
9.14 Line >> SIP Hotspot	41
9.15 Line >> Basic Settings	41
9.16 Line>>Action Plan	43
9.17 Settings >> Features	44
9.18 Settings >> Noise Reducation	46
9.19 Settings >> Media Settings	47
9.20 Settings>>Camera Settings	48
9.21 Settings >> MCAST	50
9.22 Settings >> Action	50
9.23 Settings >> Time/Date	50
9.24 Settings>>Time plan	52
9.25 Settings >> Tone	53
9.26 Call list >> Call List	54
9.27 Call list >> Web Dial	54
9.28 Function Key	55
9.29 Security >> Web Filter	59
9.30 Security >> Trust Certificates	60
9.31 Security >> Device Certificates	61
9.32 Security >> Firewall	62
9.33 Device Log	63
9.34 Security Settings	64
10 Trouble Shooting	67
10.1 Get Device System Information	67
10.2 Reboot Device	67
10.3 Device Factory Reset	67
10.4 Network Packets Capture	67
10.5 Get Device Log	68
10.6 Common Trouble Cases	68

1 Picture

picture 1 - Interface	9
Picture 2 - WEB Login	12
Picture 3 - SIP Line Configuration	12
Picture 4 - Volume Set	13
Picture 5 - Function Setting	14
Picture 6 - WEB line enable auto answer	15
Picture 7 - Enable auto answer for IP calls	15
Picture 8 - Call Waiting	16
Picture 9 - Call Waiting tone	16
Picture 10 - WEB Intercom	17
Picture 11 - MCAST	18
Picture 12 - SIP hotspot	20
Picture 13 - WEB Account	22
Picture 14 - System Setting	22
Picture 15 - Upgrade	23
Picture 16 - Web page firmware upgrade	24
Picture 17 - Auto provision settings	26
Picture 18 - Tools	29
Picture 19 - Network Basic Setting	30
Picture 20 - Service port setting interface	31
Picture 21 - Network VPN	32
Picture 22 - Network Setting	34
Picture 23 - SIP	37
Picture 24 - Basic Settings	42
Picture 25 - Line Basic Setting	42
Picture 26 - Action Plan	43
Picture 27 - Feature	44
Picture 28 - Media Settings	47
Picture 29 - Camera Settings	49
Picture 30 - Action URL	50
Picture 31 - Time/Date	51
Picture 32 - Time Plan	52
Picture 33 - Tone	54
Picture 34 - Webpage Dial	55
Picture 35 - Function Key	55
Picture 36 - Memory Key	58

Picture 37 - Multicast	59
Picture 38 - Advanced Setting	59
Picture 39 - WEB filter	60
Picture 40 - Trust Certificates	61
Picture 41 - Device Certificates	61
Picture 42 - Firewall	62
Picture 43 - Firewall rules list	63
Picture 44 - Delete firewall rules	63
Picture 45 - Security Settings	64

2 Table

Table 1 - Interface	9
Table 2 - Configuration instructions	11
Table 3 - Intercom	17
Table 4 - MCAST	18
Table 5 - SIP Hotspot	19
Table 6 - Firmware upgrade	24
Table 7 - Auto Provision	26
Table 8 - Network Basic Setting	30
Table 9 - Server Port	31
Table 10 - Network Setting	34
Table 11 - SIP	37
Table 12 - Line Basic Setting	42
Table 13 - Action Plan	43
Table 14 - Common device function Settings on the web page	44
Table 15 - Media Settings	47
Table 16 - Camera Settings	49
Table 17 - Action URL	50
Table 18 - Time/Date	51
Table 19 - Time Plan	52
Table 20 - Function Key	55
Table 21 - Memory Key	58
Table 22 - Web Multicast	59
Table 23 - Web Firewall	62
Table 24 - Security Settings	64

3 Safety Instruction

Please read the following safety notices before installing or using this unit. They are crucial for the safe and reliable operation of the device.

- Please use the product-specified power adapter. If you need to use a power adapter provided by another manufacturer due to special circumstances, please confirm that the voltage and current of the provided adapter meet the specifications of this product, and it is recommended to use a product that has passed safety certification, otherwise it may cause fire or electric shock accidents. When using this product, do not damage the power cord, do not twist, stretch and strap it, and do not press it under heavy objects or sandwich between items, otherwise it may cause fire or electric shock caused by broken power cord.
- Before using the external power supply in the package, please check the home power voltage. Inaccurate power voltage may cause fire and damage.
- Please do not damage the power cord. If power cord or plug is impaired, do not use it because it may cause fire or electric shock.
- Do not drop, knock or shake the phone. Rough handling can break internal circuit boards.
- Before using the product, please confirm that the temperature and humidity of the environment meet the working requirements of the product.
- Avoid wetting the unit with any liquid.
- Do not attempt to open it. Non-expert handling of the device could damage it. Consult your authorized dealer for help, or else it may cause fire, electric shock and breakdown.
- Do not use harsh chemicals, cleaning solvents, or strong detergents to clean it. Wipe it with a soft cloth that has been slightly dampened in a mild soap and water solution.
- When lightning, do not touch power plug, it may cause an electric shock.
- Do not install this phone in an ill-ventilated place. You are in a situation that could cause bodily injury. Before you work on any equipment, be aware of the hazards involved with electrical circuitry and be familiar with standard practices for preventing accidents.

4 Overview

A201 is a ceiling-mounted speaker that supports broadcasting functionality, offering powerful features that combine smart security and broadcasting capabilities at a competitive price point.

A201 system is highly compatible and expandable, supporting standard SIP 2.0 (RFC3261) and related RFC protocols. It is suitable for indoor scenarios and provides users with high-quality broadcasting services. Additionally, the speaker can be used with a small broadcasting system to meet audio playback needs in public areas, supporting 20 multicast zones with prioritization. It utilizes G.722 and Opus codecs to ensure a high-quality voice communication experience.

The installation method uses a mounting bracket that not only saves space but is also easy to arrange in various environments. Whether for corporate offices, educational settings, or information broadcasting in public places, this speaker delivers clear and stable audio output, making it an ideal choice for efficient communication and broadcasting solutions.

5 Install Guide

5.1 Use POE or External Power Adapter

A201, called as 'the device' horn speaker, supports two power supply modes, power supply from external power adapter or over Ethernet (POE) complied switch.

POE power supply saves the space and cost of providing the device additional power outlet. With a POE switch, the device can be powered through a single Ethernet cable which is also used for data transmission. By attaching UPS system to POE switch, the device can keep working at power outage just like traditional PSTN telephone which is powered by the telephone line.

For users who do not have POE equipment, the traditional power adaptor should be used. If the device is connected to both POE switch and external power adapter, A201 will get power supply from power adaptor in priority, and change to external power adapter once the power adaptor supply fails.

Note:

- The current PoE power supply default is AT mode. If the current PoE power supply is in AF mode, adjust the speaker power to 7W in [Device Settings] >> [Media Settings] >> [Speaker Power] to avoid the risk of over power.

Please use the power adapter supplied by Fanvil and the POE switch met the specifications to ensure the device work properly.

6 User Guide

6.1 Interface Description

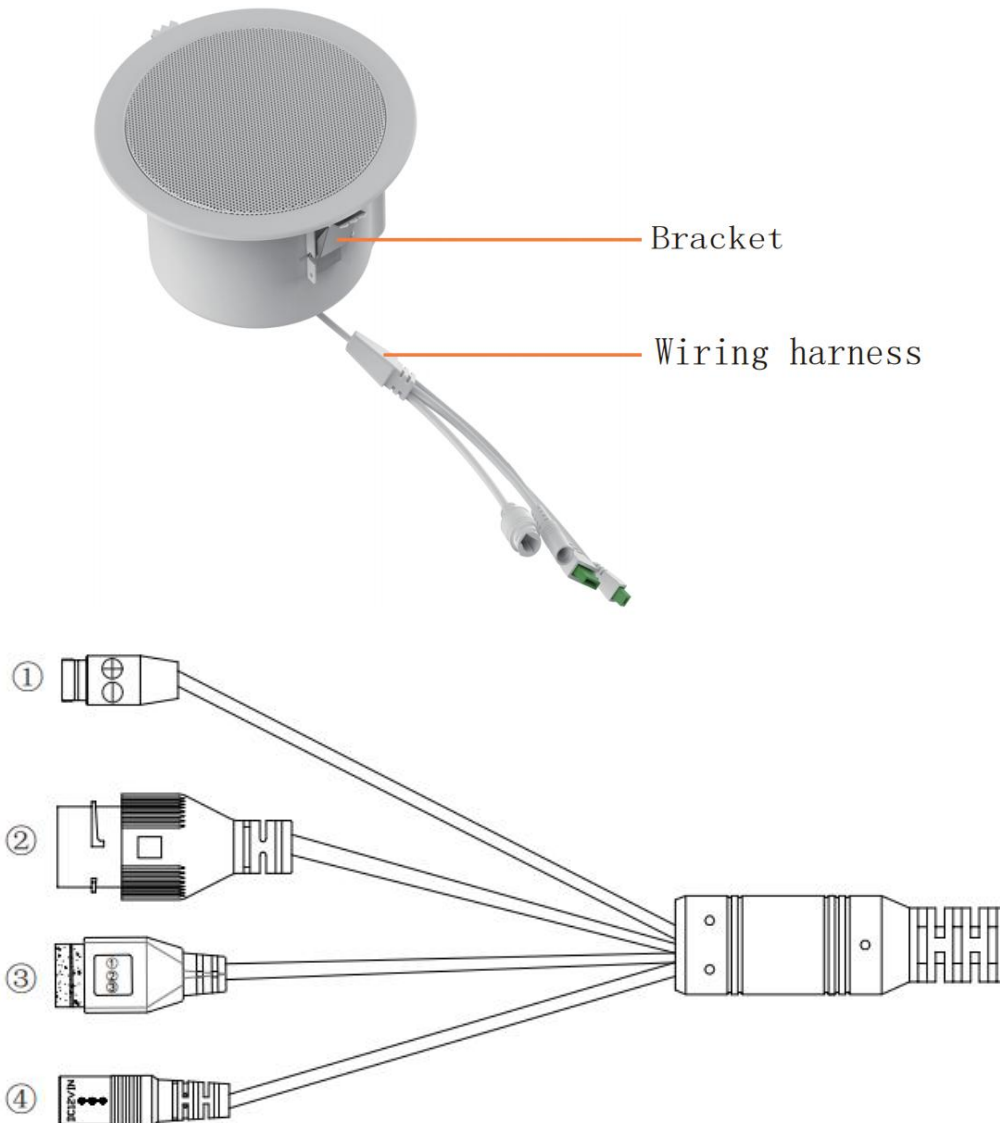

On the back of the device, there is a row of terminal blocks for connecting the power supply, indoor switches, etc., the connection is as follows:



picture 1- Interface

Table 1 - Interface

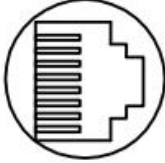
SN	Description	Interface
----	-------------	-----------

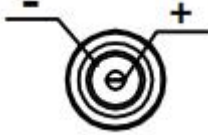
①	The short circuit input interface: input devices for connecting switches, infrared sensor, door sensor, vibration sensors etc.	
②	Ethernet interface: standard RJ45 interface, 10/100M adaptive, support PoE powered, it is recommended to use CAT5 or CAT5E network cable.	
③	The short circuit output interface: corresponding to the short-circuit input interface, login device web page settings, can be connected to electric locks, etc.	
④	Power interface: DC 24V/2A input.	

6.2 Installation Instructions

6.2.1 Device IP Address

Method one:

1. Go to the official website of Fanvil [Support] >> [Download Center] >>[Tools]>> [IPScanner] module, click and download the DeviceManager,
2. Open the IP scan tool, the tool supports LAN scan and cross network segment scan.
3. For LAN scanning:
.Click the desktop icon, run the DeviceManager tool
4. Cross-segment scan: Fill in the cross-segment setting in the upper right corner of the page in the format of: IP address/mask. That is: IP address/N.

Total: 28

Search [] Version Status [] Refresh [] 0.0.0.0/24 Rescan [] ?

Index	MAC	IP Address	Model	Version	Version Status	description
1	0c:38:3e:2f:7a:eb	172.16.7.123	i57A	1.0.0.29		--
2	0c:38:3e:16:94:c4	172.16.7.129	V62	T2.12.16.3.2		--
3	0c:38:3e:26:be:66	172.16.7.149	X5U-V2	2.12.16.15		--
4	0c:11:05:18:81:b9	172.16.7.120	C319	119.30.1.242		--
5	0c:38:3e:2f:c2:36	172.16.7.100	X303	2.12.4.1		--
6	0c:38:3e:2f:c2:02	172.16.7.192	X301	2.12.4.1		--
7	34:3a:6e:8c:87:16	172.16.7.126	i64	2.12.19		--
8	00:a8:59:ff:b2:43	172.16.7.93	GW11G	2.4.5		--
9	00:a8:59:ff:b2:43	172.16.7.93	GW11G	2.4.5		--
10	00:a8:59:ef:4c:71	172.16.7.108	IP Phone	2.4.3		--
11	0c:38:3e:3d:b0:20	172.16.7.103	X6U	2.4.11		--
12	00:a8:59:ff:b2:62	172.16.7.111	GW12G	2.4.5		--
13	0c:38:3e:2f:7a:ed	172.16.7.118	i57A	1.0.0.71		--
14	0c:38:3e:30:10:e5	172.16.7.107	X7	2.4.5		--
15	00:a8:59:db:15:5e	172.16.7.102	X6U	2.4.12		--
16	00:02:40:6c:2b:bd	172.16.7.140	M710U	T2.12.4-backup-Versi		--

Table 2 - Configuration instructions

Default configuration			
DHCP mode	Default enable	Static IP	192.168.1.128
		Server port	80

6.3 WEB Configuration

When the device and your computer are successfully connected to the network, enter the IP address of the device on the browser as `http://xxx.xxx.xxx.xxx/` and you can see the login interface of the web page management.



Picture 2 - WEB Login

The username and password should be correct to log in to the web page. **The default username and password are "admin"**. For the specific details of the operation of the web page, please refer to [9 Web Configurations](#)

6.4 SIP Configurations

At least one SIP line should be configured properly to enable the telephony service. The line configuration is like a virtualized SIM card. Just like a SIM card on a mobile phone, it stores the service provider and the account information used for registration and authentication. When the device is applied with the configuration, it will register the device to the service provider with the server's address and user's authentication as stored in the configurations.

The SIP line configuration should be set via the WEB configuration page by entering the correct information such as phone number, authentication name/password, SIP server address, server port, etc. which are provided by the SIP server administrator.

- WEB interface: After login into the phone page, enter [**Line**] >> [**SIP**] and select **SIP1/SIP2** for configuration, click apply to complete registration after configuration, as shown below:

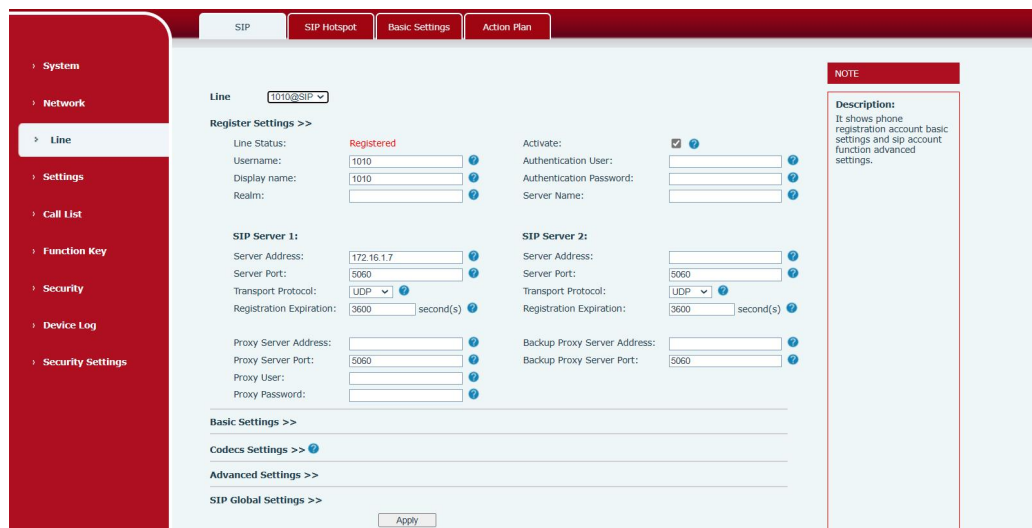

Picture 3 - SIP Line Configuration

6.5 Volume Setting

Set the volume (if the speaker or microphone is not connected, you can skip it)

[Settings] >> [Media Settings] >> [Media Settings], as shown below, click **[Apply]**.

Speakerphone Volume: Set the speaker output volume.

Handfree Mic Gain: microphone volume level.

Codecs Settings >>

Media Settings >>

Default Ring Type:	1.wav		Speakerphone Ring Volume:	5	(0~9)
Speakerphone Volume:	7	(1~9)			
Speakerphone SignalTone Volume:	5	(1~9)			
DTMF Payload Type:	101	(96~127)			
Handfree Mic Gain:	3	(1~9)			
OPUS Payload Type:	107	(96~127)	OPUS Sample Rate:	OPUS-NB	
ILBC Payload Type:	97	(96~127)	ILBC Payload Length:	20ms	
Enable VAD:	<input type="checkbox"/>				
Audio Delay:	0	(0~1000ms)			

RTP Control Protocol(RTCP) Settings >>

RTP Settings >>

Alert Info Ring Settings >>

Apply

Picture 4- Volume Set

7 Basic Function

7.1 Making Calls

After setting the function key to Memory key and setting the number, press the function key to immediately call out the set number, as shown below:

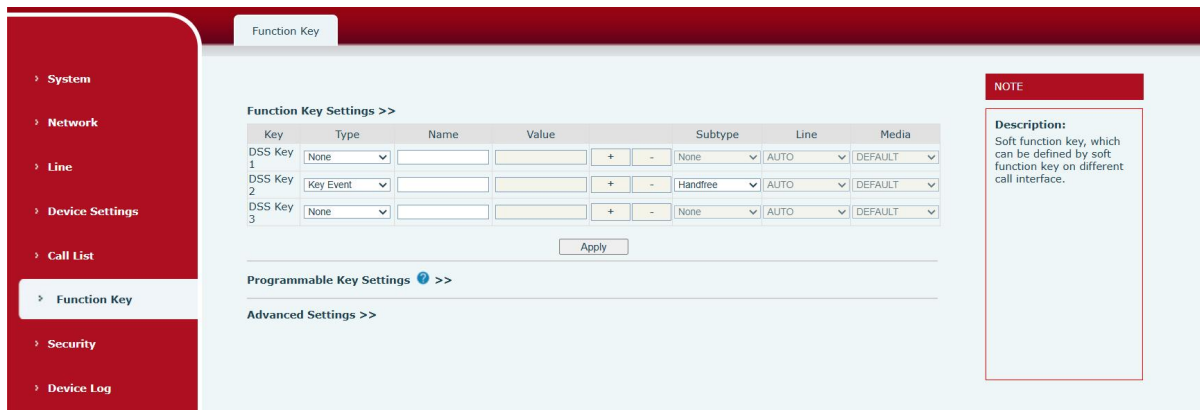

Picture 5- Function Setting

See detailed configuration instructions [9.29 Function Key](#)

7.2 Answering Calls

After setting up the automatic answer and setting up the automatic answer time, it will hear the ringing bell within the set time and automatically answer the call after timeout. Cancel automatic answering. When a call comes in, you will hear the ringing bell and will not answer the phone over time.

7.3 End of the Call

When there is a call, you can press the Call button or hang up the key to hang up the call, the Call button is set to end the call by default. See detailed configuration instructions [9.29 Function Key](#).

7.4 Auto Answer

The user can turn off the auto-answer function (enabled by default) on the device webpage, and the ring tone will be heard after the shutdown, and the auto-answer will not time out.

Web interface:

Enter [Line] >> [SIP], Enable auto answer and set auto answer time and click submit.

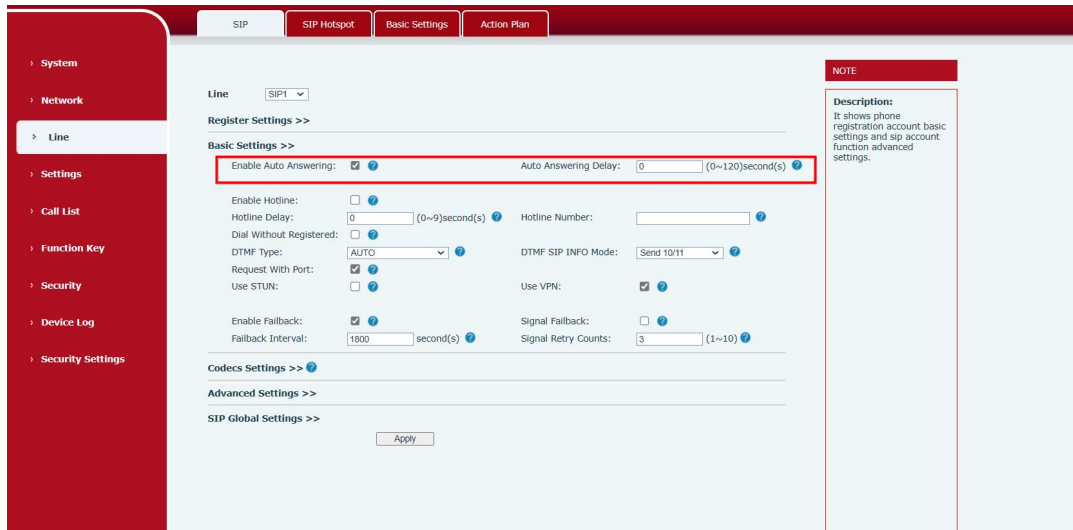

Picture 6 - WEB line enable auto answer

SIP P2P auto answering:

Enter [Line]>>[Basic settings], Enable auto answer and set auto answer time and click submit.

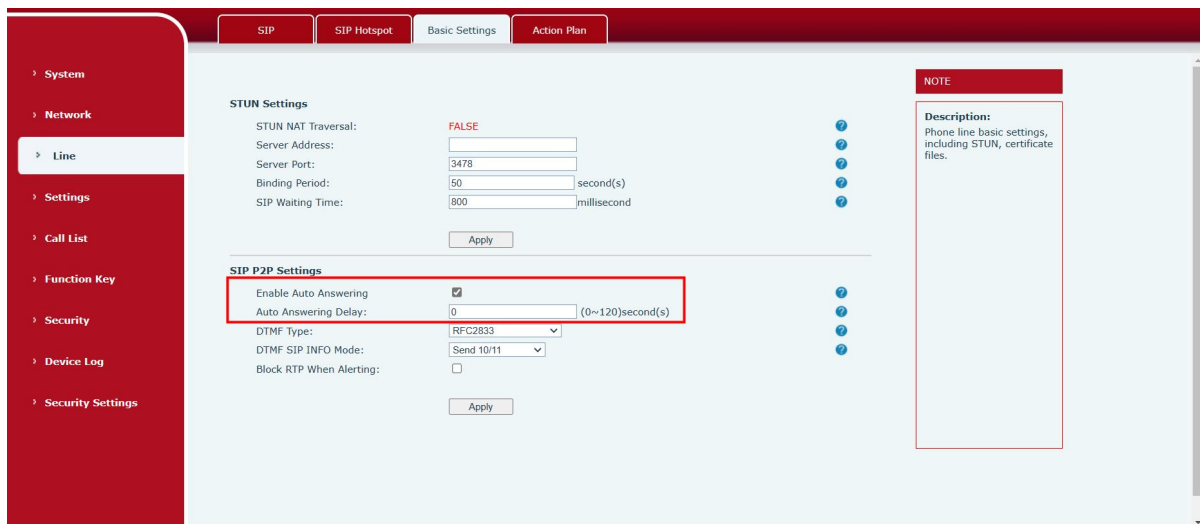

Picture 7- Enable auto answer for IP calls

- Auto Answer Timeout (0~120)

The range can be set to 0~120s, and the call will be answered automatically when the timeout is set.

7.5 Call Waiting

- Enable call waiting: new calls can be accepted during a call.
- Disable call waiting: new calls will be automatically rejected and a busy signal will be prompted
- Enable call waiting tone: when you receive a new call on the line, the device will beep.

Users can enable/disable call waiting in the device interface and the web interface.

- Web interface: enter **[Settings]** >> **[Features]**, enable/disable call waiting, enable/disable call waiting tone.

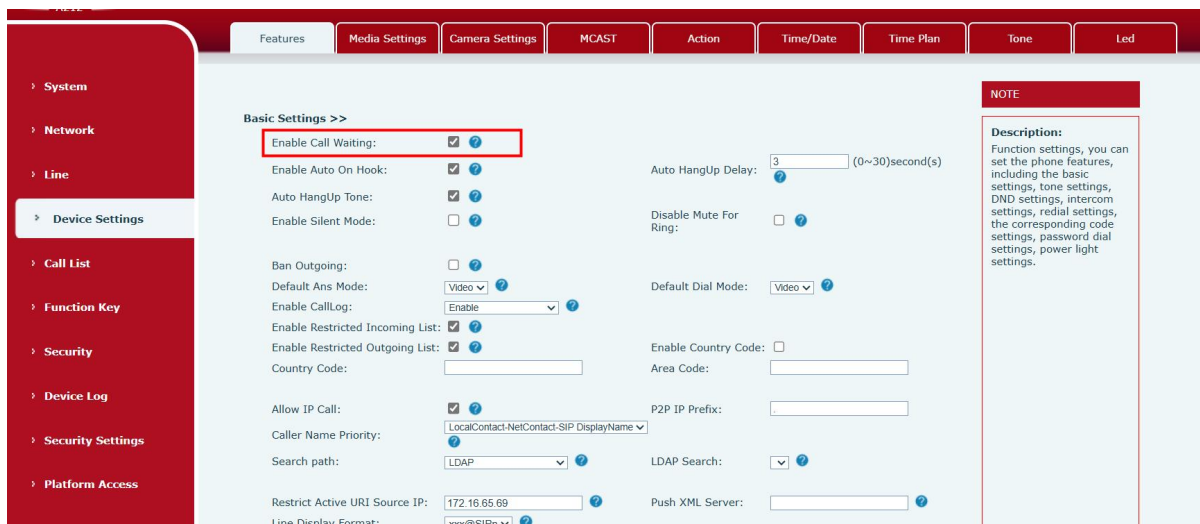

Picture 8 - Call Waiting

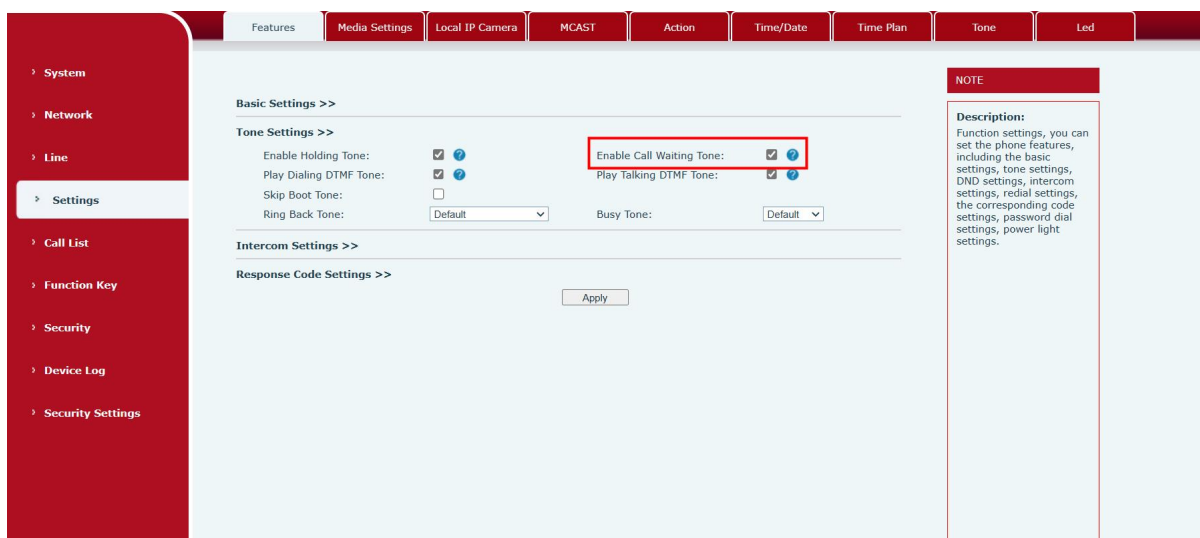

Picture 9 - Call Waiting tone

8 Advance Function

8.1 Intercom

The equipment can answer intercom calls automatically.

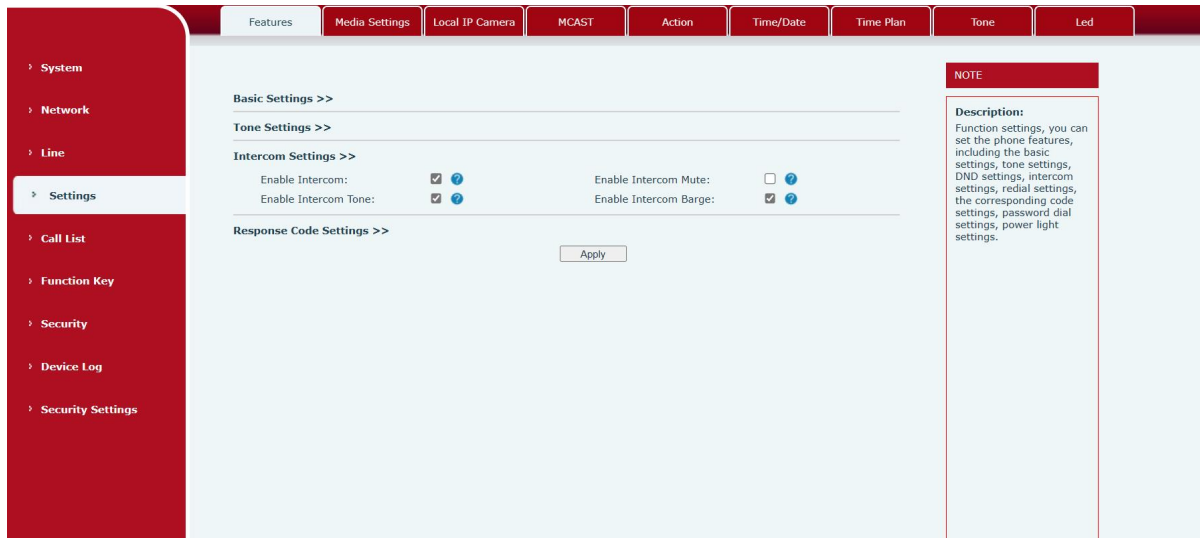

Picture 10 - WEB Intercom

Table 3- Intercom

Parameters	Description
Enable Intercom	When the intercom system is enabled, the device will accept the SIP header call-info of the Call request Command automatic call
Enable Intercom Barge	If the option is enabled, device will answer the intercom call automatically while it is in a normal call, and it will reject new intercom call if there is already one intercome call
Enable Intercom Tone	Enable mute during intercom mode
Enable Intercom Mute	Enable mute mode during the intercom call

8.2 MCAST

This feature allows user to make some kind of broadcast call to people who are in multicast group. User can configure a multicast DSS Key on the phone, which allows user to send a Real Time Transport Protocol (RTP) stream to the pre-configured multicast address without involving

SIP signaling. You can also configure the phone to receive an RTP stream from pre-configured multicast listening address without involving SIP signaling. You can specify up to 10 multicast listening addresses.

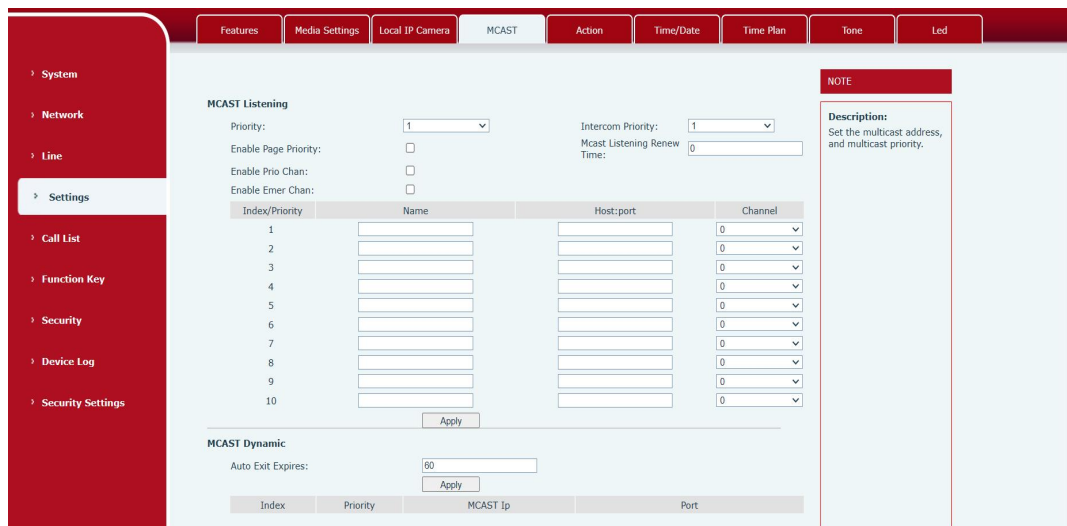

Picture 11 - MCAST

Table 4- MCAST

Parameters	Description
Priority	Defines the priority in the current call, with 1 being the highest priority and 10 being the lowest.
Intercom Priority	The priority of the intercom call, 1 is the highest priority, 10 is the lowest, and the high priority can be inserted into the low priority
Enable Page Priority	Regardless of which of the two multicast groups is called in first, the device will receive the higher priority multicast first.
Enable Prio Chan	Once enabled, the same port and channel can only be connected. Channel 24 is the priority channel, higher than 1-23; A channel of 0 indicates that no channel is used
Enable Emer Chan	When enabled, channel 25 has the highest priority
Mcast Listening Renew Time	Set the wait time to renew to the multicast

Multicast:

- Go to web page of [Function Key] >> [Function Key], select the type to multicast, set the multicast address, and select the codec.
- Click Apply.
- Set up the name, host and port of the receiving multicast on the web page of [Settings] >> [MCAST].
- Press the DSSKey of Multicast Key which you set.

- Receive end will receive multicast call and play multicast automatically.

MCAST Dynamic:

Description: send multicast configuration information through SIP notify signaling. After receiving the message, the device configures it to the system for multicast monitoring or cancels multicast monitoring in the system.

8.3 Hotspot

SIP hotspot is a simple utility. Its configuration is simple, which can realize the function of group vibration and expand the quantity of sip account. Take one device A as the SIP hotspot and the other devices (B, C) as the SIP hotspot client. When someone calls device A, devices A, B, and C will ring, and if any of them answer, the other devices will stop ringing and not be able to answer at the same time. When A B or C device is called out, it is called out with A SIP number registered with device A.

Table 5 - SIP Hotspot

Parameters	Description
Enable Hotspot	Enable or disable hotspot
Mode	This device can only be used as a client
Monitor Type	The monitoring type can be broadcast or multicast. If you want to restrict broadcast packets in the network, you can choose multicast. The type of monitoring on the server side and the client side must be the same, for example, when the device on the client side is selected for multicast, the device on the SIP hotspot server side must also be set for multicast
Monitor Address	The multicast address used by the client and server when the monitoring type is multicast. If broadcasting is used, this address does not need to be configured, and the system will communicate by default using the broadcast address of the device's wan port IP
Local Port	It shows the Hotspot listening port. Enter the custom hotspot communication port. The ports of the server and client need to be consistent
Name	Fill in the name of the SIP hotspot. This configuration is used to identify different hotspots on the network to avoid connection conflicts
Line Settings	Sets whether to enable the SIP hotspot function on the corresponding SIP line

Client Settings:

As a SIP hotspot client, there is no need to set up a SIP account, which is automatically

acquired and configured when the device is enabled. Just change the mode to "client" and the other options are set in the same way as the hotspot.

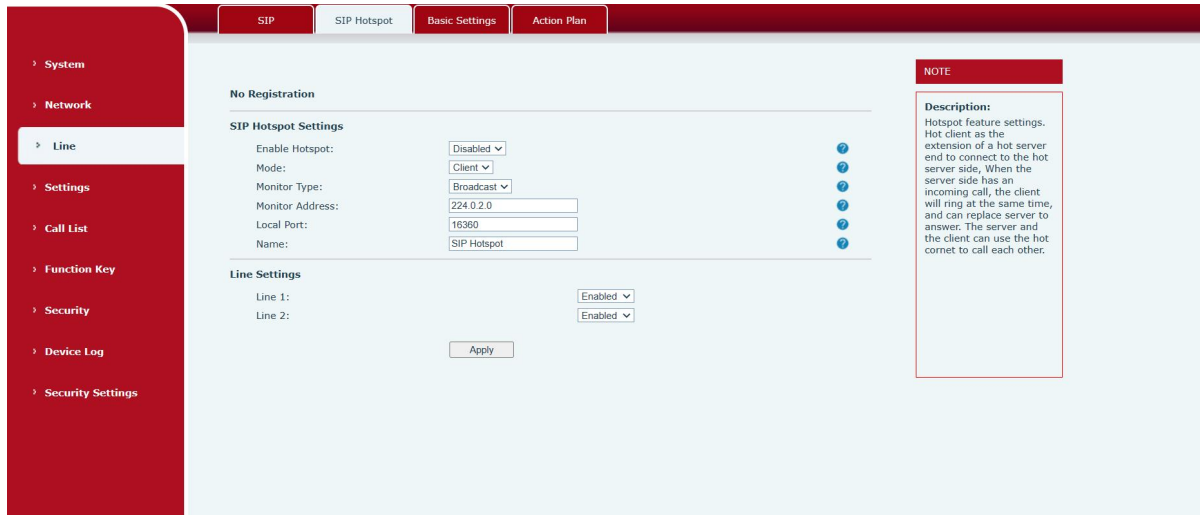

Picture 12 - SIP hotspot

The device is the hotspot server, and the default extension is 0. The device ACTS as a client, and the extension number is increased from 1 (the extension number can be viewed through the [SIP hotspot] page of the webpage).

Calling internal extension:

- The hotspot server and client can dial each other through the extension number before
- Extension 1 dials extension 0

9 Web Configurations

9.1 Web Page Authentication

Users can log into the device's web page to manage user device information and operate the device. Users must provide the correct user name and password to log in. If the password is entered incorrectly three times, it will be locked and can be entered again after 5 minutes.

The details are as follows:

- If an IP is logged in more than the specified number of times with a different user name, it will be locked
- If a user name logs in more than a specified number of times on a different IP, it is also locked

9.2 System >> Information

User can get the system information of the device in this page including,

- Model
- Hardware Version
- Software Version
- Uptime
- Last uptime
- MEMInfo
- System Time

And summarization of network status,

- Network Mode
- MAC Address
- IP
- Subnet Mask
- Default Gateway

Besides, summarization of SIP account status,

- SIP User
- SIP account status (Registered / Unapplied / Trying / Timeout)

9.3 System >> Account

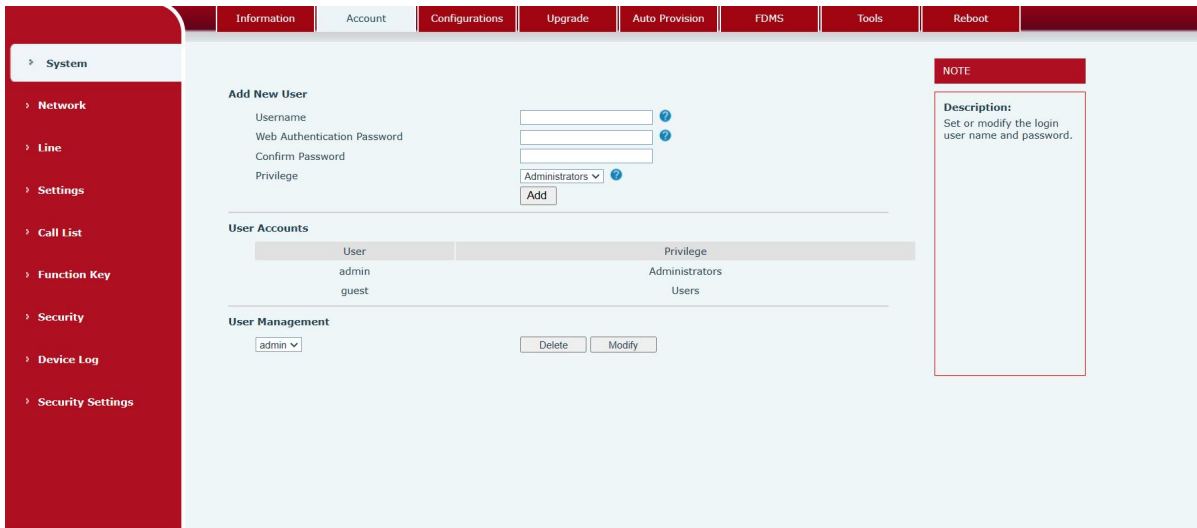

Picture 13- WEB Account

On this page the user can change the password for the login page. Users with administrator rights can also add or delete users, manage users, and set permissions and passwords for new users

9.4 System >> Configurations

On this page, users with administrator privileges can view, export, or import the phone configuration, or restore the phone to factory Settings.

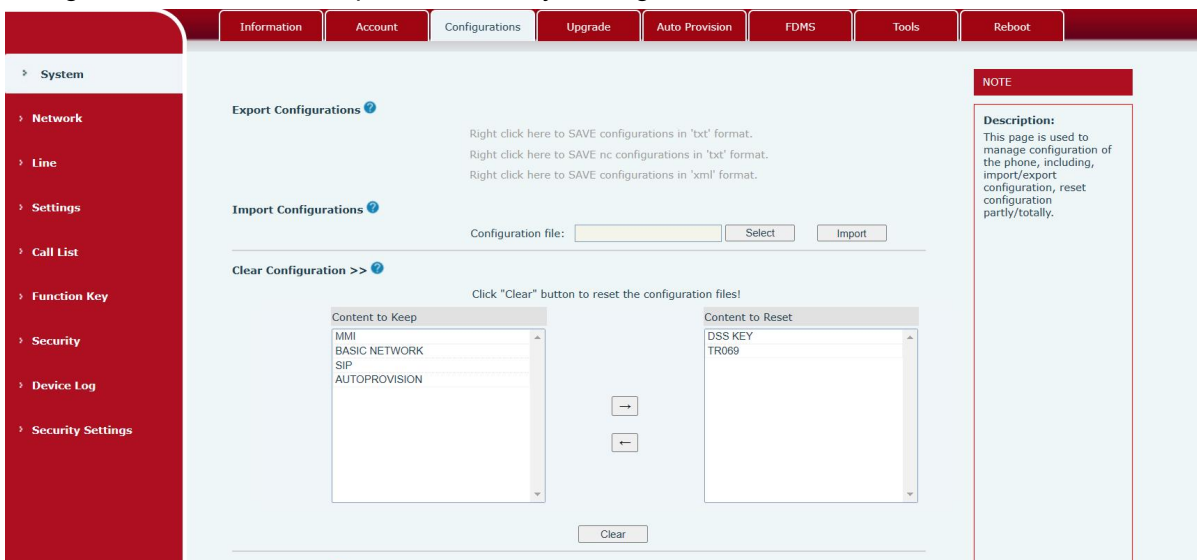

Picture 14 - System Setting

■ **Export Configurations**

Right click to select target save as, that is, to download the device's configuration file, suffix “.txt”. (note: profile export requires administrator privileges)

■ **Import Configurations**

Import the configuration file of Settings. The device will restart automatically after successful import, and the configuration will take effect after restart

■ **Clear Configurations**

Select the module in the configuration file to clear.

SIP: account configuration.

AUTOPROVISION: automatically upgrades the configuration

TR069:TR069 related configuration

MMI: MMI module, including authentication user information, web access protocol, etc.

DSS Key: DSS Key configuration

■ **Clear Tables**

Select the local data table to be cleared, all selected by default.

■ **Reset Phone**

The phone data will be cleared, including configuration and database tables.

9.5 System >> Upgrade

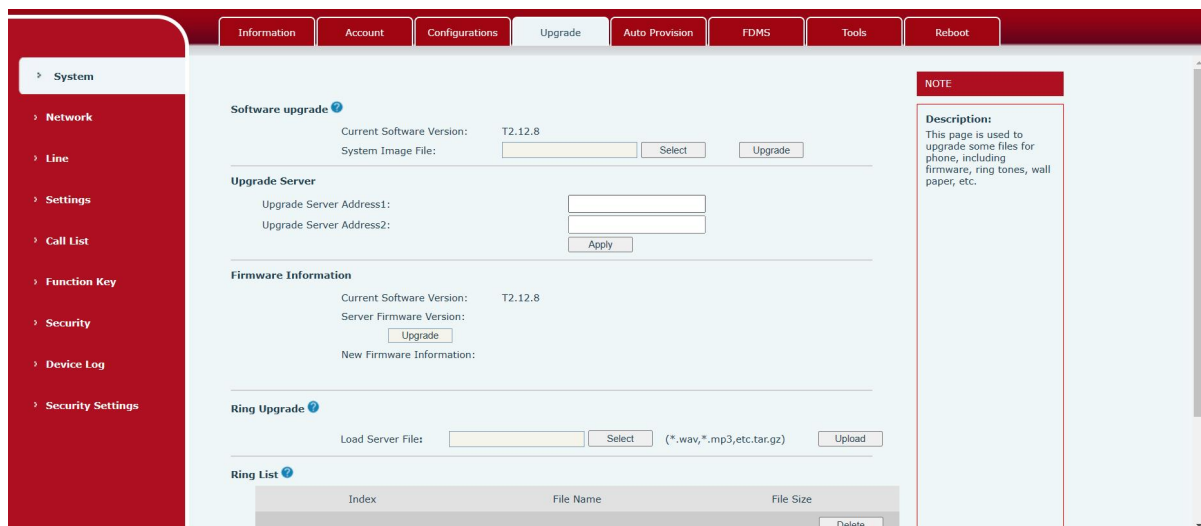

Picture 15- Upgrade

Upgrade the software version of the device, and upgrade to the new version through the webpage. After the upgrade, the device will automatically restart and update to the new version.

Click select, select the version and then click upgrade.

Upgrade the ringtone, support wav and MP3 format.

Firmware Upgrade:

- Web page: Login phone web page, go to **[System]** >> **[Upgrade]**.

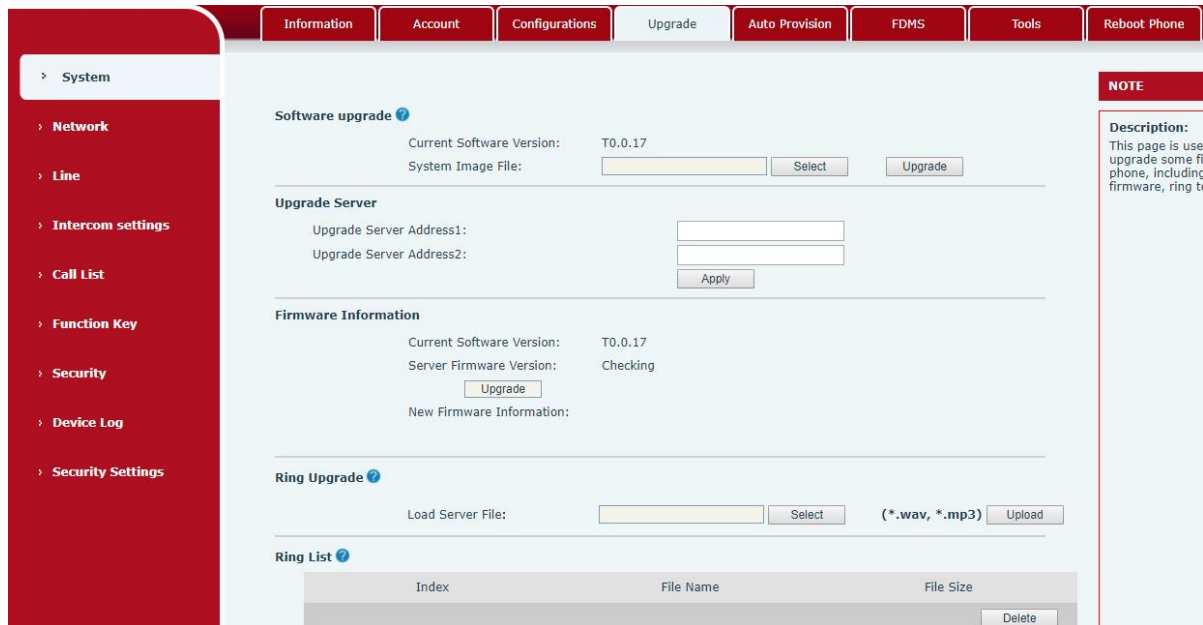

Picture 16 - Web page firmware upgrade

Table 6- Firmware upgrade

Parameter	Description
Upgrade server	
Enable Auto Upgrade	Enable automatic upgrade, If there is a new version txt and new software firmware on the server, phone will show a prompt upgrade message after Update Interval.
Upgrade Server Address1	Set available upgrade server address.
Upgrade Server Address2	Set available upgrade server address.
Update Interval	Set Update Interval.
Firmware Information	
Current Software Version	It will show Current Software Version.
Server Firmware Version	It will show Server Firmware Version.
[Upgrade] button	If there is a new version txt and new software firmware on the server, the page will display version information and upgrade button will become available; Click [Upgrade] button to upgrade the new firmware.
New version description	When there is a corresponding TXT file and version on

information	the server side, the TXT and version information will be displayed under the new version description information.
-------------	---

- The file requested from the server is a TXT file called vendor_model_hw10.txt.Hw followed by the hardware version number, it will be written as hw10 if no difference on hardware. All Spaces in the filename are replaced by underline.
- The URL requested by the phone is HTTP:// server address/vendor_Model_hw10.txt: The new version and the requested file should be placed in the download directory of the HTTP server, as shown in the figure:

名称	修改日期	类型	大小
fanvil_x6_hvw1_0.txt	2018/9/11 17:57	文本文档	1 KB
fanvil_x6_hvw1_1.txt	2018/9/11 17:57	文本文档	1 KB
fanvil_x6_hvw1_2.txt	2018/9/11 17:57	文本文档	1 KB
fanvil_x6_hvw1_3.txt	2018/9/11 17:57	文本文档	1 KB
x6-6904-P0.12.12-1.6.3-2502T2018-0...	2018/8/21 19:52	WinRAR 压缩文...	35,847 KB

- TXT file format must be UTF-8
- vendor_model_hw10.TXT The file format is as follows:
Version=1.6.3 #Firmware
Firmware=xxx/xxx.z #URL , Relative paths are supported and absolute paths are possible, distinguished by the presence of protocol headers.
BuildTime=2018.09.11 20:00
Info=TXT|XML

Xxxxx
Xxxxx
Xxxxx
Xxxxx
- After the interval of update cycle arrives, if the server has available files and versions, the phone will prompt as shown below. Click [view] to check the version information and upgrade.

9.6 System >> Auto Provision

Webpage: Login and go to [System] >> [Auto provision].

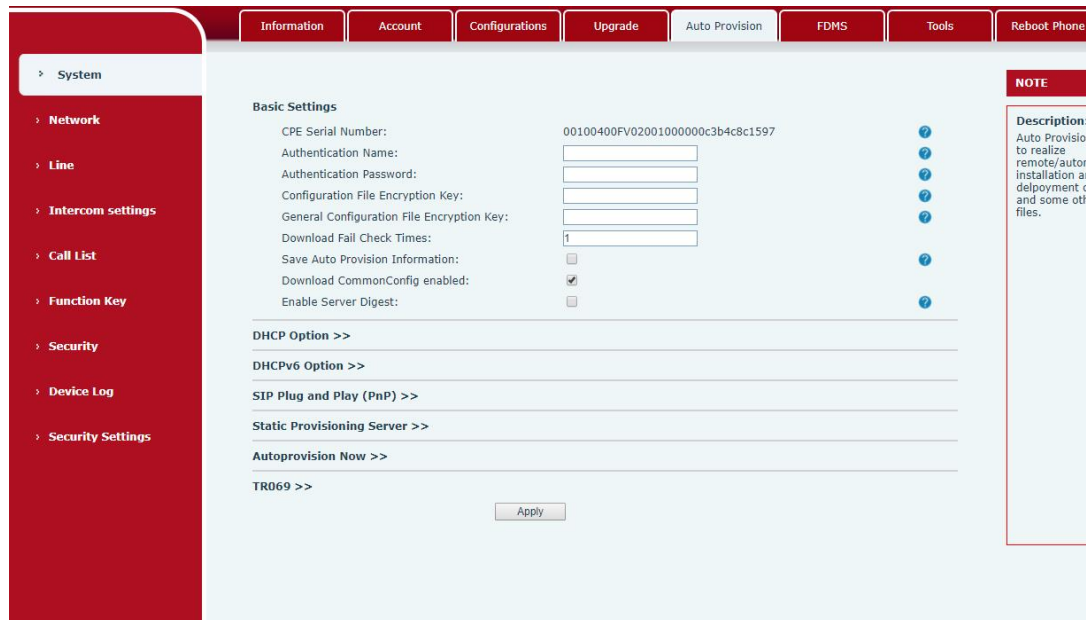

Picture 17- Auto provision settings

Fanvil devices support SIP PnP, DHCP Options, Static provision, TR069. If all of the 4 methods are enabled, the priority from high to low as below:

PNP>DHCP>TR069> Static Provisioning

Transferring protocol: FTP、 TFTP、 HTTP、 HTTPS

Table 7- Auto Provision

Auto provision	
Parameters	Description
Basic settings	
Current Configuration Version	Shows the current config file's version. If the version of the downloaded configuration file is same with this one, the configuration file will not be applied. If the device confirm the configuration by the Digest method, once the configuration of server is modified or the device's configurations are different from server's, the device will download and apply the configurations.
General Configuration Version	Shows the common config file's version. If the version of the downloaded configuration file is same with this one, the configuration file will not be applied. If the device confirm the configuration by the Digest method, once the configuration of server is modified or the device's configurations are different from server's, the device will download and apply the configurations.
CPE Serial Number	Serial number of the equipment
Authentication Name	Username for configuration server. Used for FTP/HTTP/HTTPS.

	If this is blank the phone will use anonymous
Authentication Password	Password for configuration server. Used for FTP/HTTP/HTTPS.
Configuration File Encryption Key	Encryption key for the configuration file
General Configuration File Encryption Key	Encryption key for common configuration file
Download Fail Check Times	The default value is 5. If the download configuration fails, it will be downloaded 5 times.
Enable Get Digest From Server	When the feature is enable, if the configuration of server is changed, phone will download and update.
Download CommonConfig enabled	Set whether to enable downloading generic profiles
Enable Server Digest	computer digest by server before downloading
Provision Config Priority	Provision Config Priority
DHCP Option	
Option Value	The equipment supports configuration from Option 43, Option 66, or a Custom DHCP Option. It may also be disabled.
Custom Option Value	Custom option number. Must be from 128 to 254.
Enable DHCP Option 120	Set the SIP server address through DHCP Option 120.
DHCPv6 Option	
Option Value	DHCP Option type for Auto Provisioning.
Custom Option Value	When Option Value is selected as Custom Option, you can customize the value of the Option, which ranges from 128~254
SIP Plug and Play (PnP)	
Enable SIP PnP	Whether enable PnP or not. If PnP is enable, phone will send a SIP SUBSCRIBE message with broadcast method. Any server can support the feature will respond and send a Notify with URL to phone. Phone could get the configuration file with the URL.
Server Address	Broadcast address. As default, it is 224.0.0.0.
Server Port	PnP port
Transport Protocol	PnP protocol, TCP or UDP.
Update Interval	PnP message interval.

Static Provisioning Server	
Server Address	Set FTP/TFTP/HTTP server IP address for auto update. The address can be an IP address or Domain name with subdirectory.
Configuration File Name	The configuration file name. If it is empty, phone will request the common file and device file which is named as its MAC address. The file name could be a common name, \$mac.cfg, \$input.cfg. The file format supports CFG/TXT/XML.
Protocol Type	Transferring protocol type, supports FTP、TFTP、HTTP and HTTPS
Update Interval	Configuration file update interval time. As default it is 1, means phone will check the update every 1 hour.
Update Mode	Provision Mode. 1. Disabled. 2. Update after reboot. 3. Update after interval.
Autoprovision Now	
TR069	
Enable TR069	Enable TR069 after selection
Enable TR069 Warning Tone	If TR069 is enabled, there will be a prompt tone when connecting.
ACS Server Type	There are 2 options Serve type, common and CTC.
ACS Server URL	ACS server address
ACS User	ACS server username (up to is 59 character)
ACS Password	ACS server password (up to is 59 character)
STUN server address	Enter the STUN address
Enable the STUN	Enable the STUN
TLS Version	TLS Version
INFORM Sending Period	TR069 message cycle. Valid Value:1~9999 seconds.

9.7 System >> Tools

This page gives the user the tools to solve the problem.

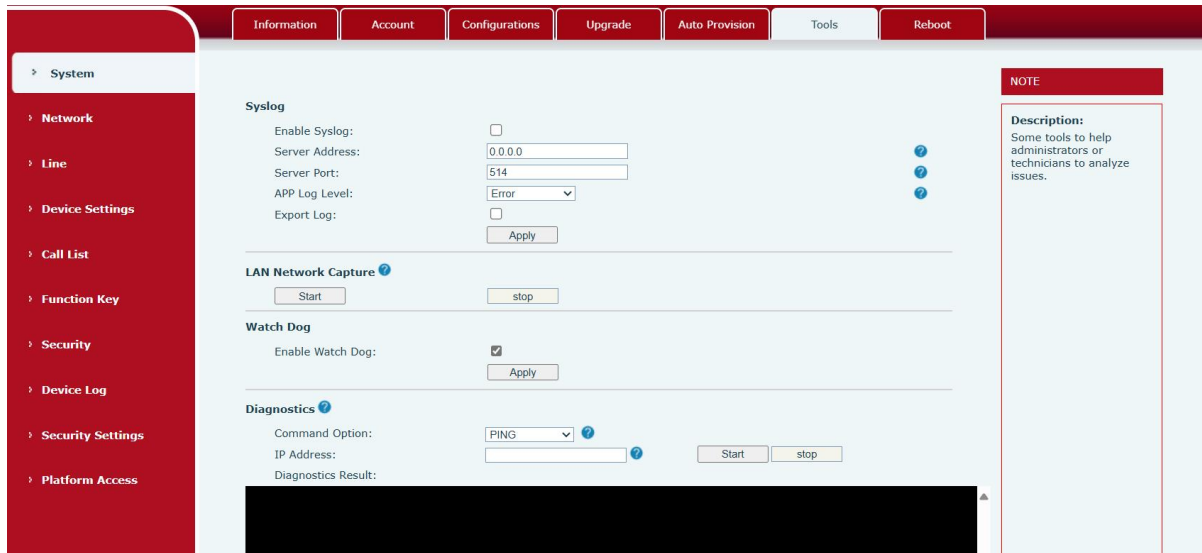

Picture 18 - Tools

Syslog: When enabled, set the Syslog software address, and log information of the device will be recorded in the Syslog software during operation. If there is any problem, log information can be analyzed by Fanvil technical support.

9.8 System>>Reboot

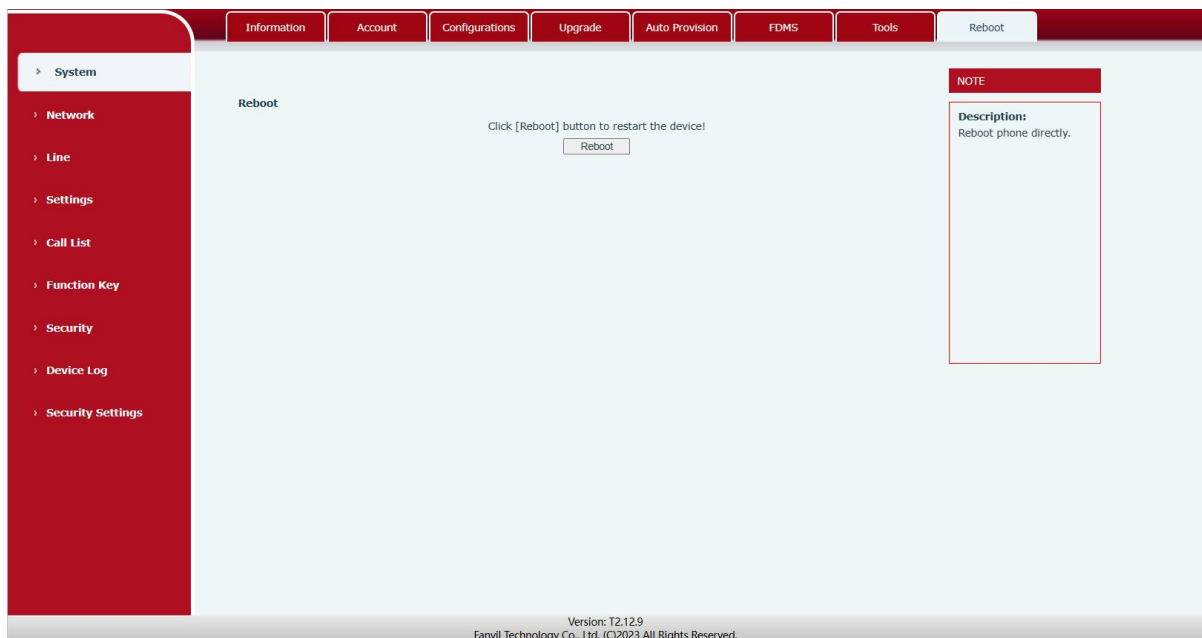

9.9 Network >> Basic

This page allows users to configure network connection types and parameters.

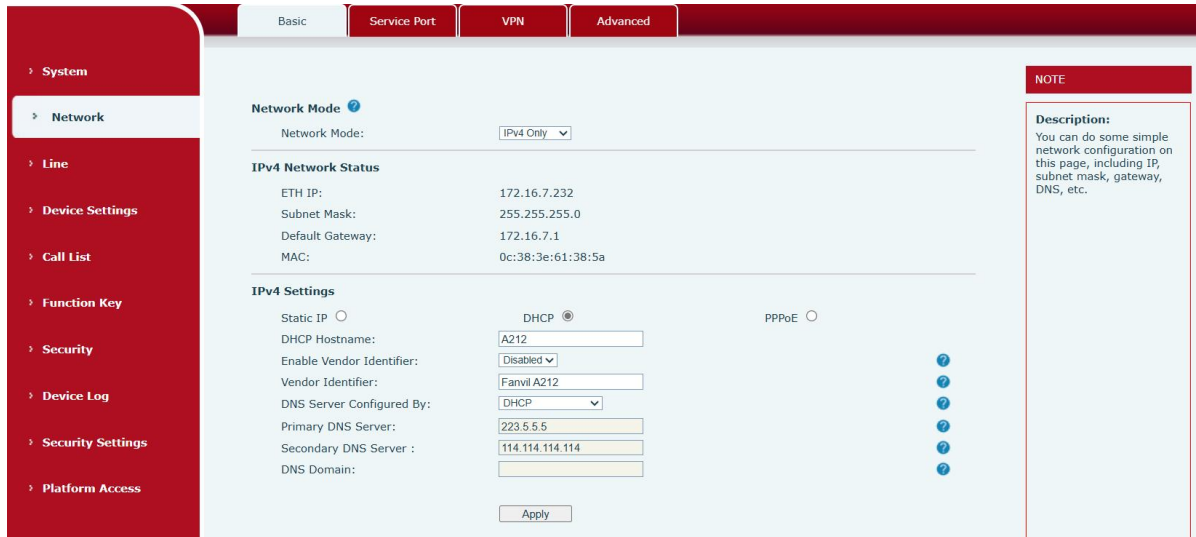

Picture 19 - Network Basic Setting

Table 8 - Network Basic Setting

Field Name	Explanation
Net Type	IPv4, IPv6, IPv4 and IPv6 three modes
IPv4 Network Status	
IP	The current IP address of the equipment
Subnet mask	The current Subnet Mask
Default gateway	The current Gateway IP address
MAC	The MAC address of the equipment
MAC Time stamp	Display the time when the device gets the MAC address
Settings	
Select the appropriate network mode. The equipment supports three network modes:	
Static IP	Network parameters must be entered manually and will not change. All parameters are provided by the ISP.
DHCP	Network parameters are provided automatically by a DHCP server.
PPPoE	Account and Password must be input manually. These are provided by your ISP.
If Static IP is chosen, the screen below will appear. Enter values provided by the ISP.	
DHCP Hostname	Set the name that is displayed when DHCP scanning
DNS Server	Select the Configured mode of the DNS Server.

Configured by	
Primary DNS Server	Enter the server address of the Primary DNS.
Secondary DNS Server	Enter the server address of the Secondary DNS.
<p>attention:</p> <p>1) After setting the parameters, click 【Apply】 to take effect.</p> <p>2) If you change the IP address, the webpage will no longer responds, please enter the new IP address in web browser to access the device.</p> <p>3) If the system USES DHCP to obtain IP when device boots up, and the network address of the DHCP Server is the same as the network address of the system LAN, then after the system obtains the DHCP IP, it will add 1 to the last bit of the network address of LAN and modify the IP address segment of the DHCP Server of LAN. If the DHCP access is reconnected to the WAN after the system is started, and the network address assigned by the DHCP server is the same as that of the LAN, then the WAN will not be able to obtain IP access to the network</p>	

9.10 Network >> Service Port

This page provides the settings of webpage login protocol, protocol port and RTP port.

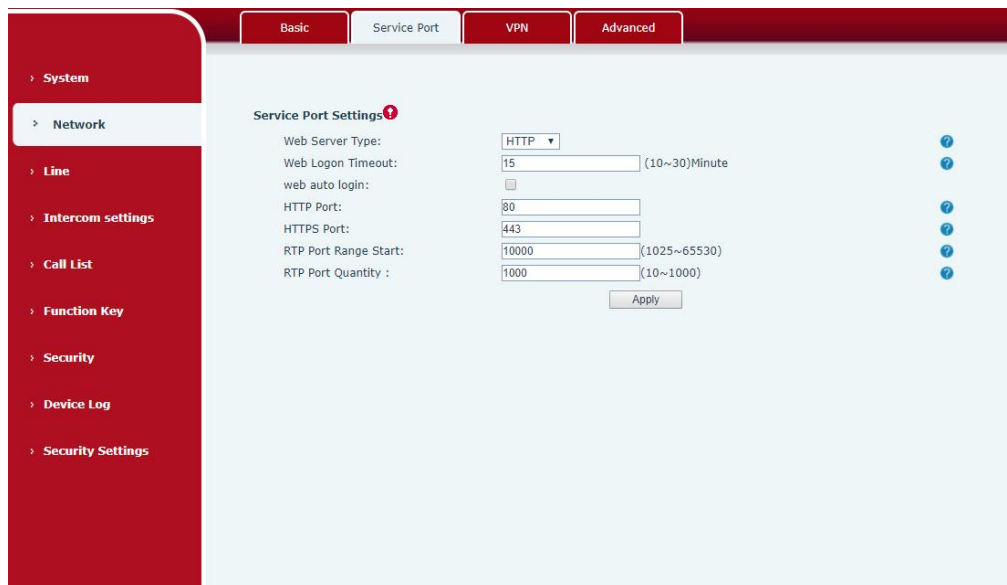

Picture 20- Service port setting interface

Table 9- Server Port

Parameter	Description
Web server type	Restart after setting takes effect. Optional web login as HTTP/HTTPS
Web login timeout	The default is 15 minutes, the timeout will automatically log out of the login page, and you need to log in again
Web page automatic login	No need to enter the user name and password after the timeout, it will automatically log in to the web page.
HTTP port	The default is 80, if you want system security, you can set other port Such as: 8080, web page login: HTTP://ip:8080
HTTPS port	The default is 443, same as HTTP port usage
RTP port start range	The value range is 1025-65535. The value of rtp port starts from the initial value set. Each time a call is made, the value of the voice and video ports is increased by 2
RTP port quantity	Number of calls

9.11 Network>>VPN

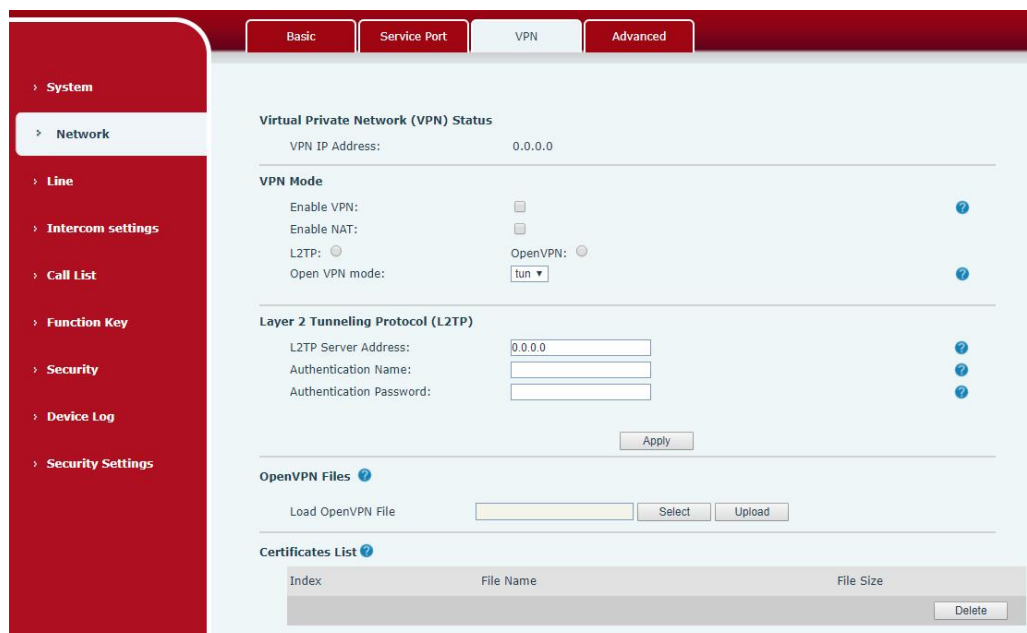

Picture 21- Network VPN

Virtual Private Network (VPN) is a technology to allow device to create a tunneling connection to a server and becomes part of the server's network. The network transmission of the device may be routed through the VPN server.

For some users, especially enterprise users, a VPN connection might be required to be established before activate a line registration. The device supports two VPN modes, Layer 2 Transportation Protocol (L2TP) and OpenVPN.

The VPN connection must be configured and started (or stopped) from the device web portal.

■ L2TP

NOTICE! The device only supports non-encrypted basic authentication and non-encrypted data tunneling. For users who need data encryption, please use OpenVPN instead.

To establish a L2TP connection, users should log in to the device web portal, open page [Network] -> [VPN]. In VPN Mode, check the “Enable VPN” option and select “L2TP”, then fill in the L2TP server address, Authentication Username, and Authentication Password in the L2TP section. Press “Apply” then the device will try to connect to the L2TP server.

When the VPN connection established, the VPN IP Address should be displayed in the VPN status. There may be some delay of the connection establishment. User may need to refresh the page to update the status.

Once the VPN is configured, the device will try to connect to the VPN automatically when the device boots up every time until user disable it. Sometimes, if the VPN connection does not established immediately, user may try to reboot the device and check if VPN connection established after reboot.

■ OpenVPN

To establish an OpenVPN connection, user should get the following authentication and configuration files from the OpenVPN hosting provider and name them as the following,

OpenVPN Configuration file:	client.ovpn
CA Root Certification:	ca.crt
Client Certification:	client.crt
Client Key:	client.key

User then upload these files to the device in the web page [Network] -> [VPN], Section OpenVPN Files. Then user should check “Enable VPN” and select “OpenVPN” in VPN Mode and click “Apply” to enable OpenVPN connection.

Same as L2TP connection, the connection will be established every time when system rebooted until user disable it manually.

9.12 Network >> Advanced

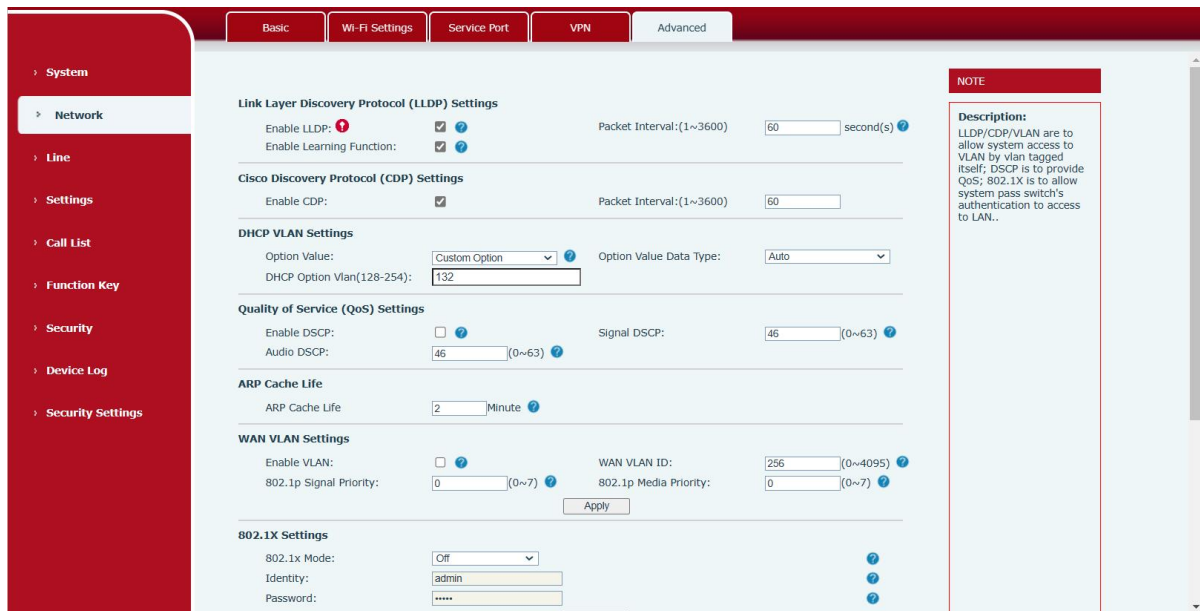

Picture 22 - Network Setting

Network advanced Settings are typically configured by IT administrators to improve the quality of device service.

Table 10- Network Setting

Field Name	Explanation
LLDP Settings	
Enable LLDP	Enable or disable LLDP
Packet Interval	LLDP Send detection cycle
Enable Learning Function	Learn the discovered device information on the device
QoS Settings	
Enable DSCP	Enable DSCP to get best offset QoS for voice quality.
Signal DSCP	DSCP value for SIP messages.
Audio DSCP	DSCP value for voice RTP data.
ARP Cache Life	Set ARP cache life.
DHCP VLAN Settings	
parameters values	128-254, Obtain the VLAN value through DHCP

WAN port virtual Wan	
WAN port virtual Wan	WAN port Settings
LAN port virtual LAN	
LAN port virtual LAN	LAN port Settings
802.1X	
Enable 802.1X	Enable or disable 802.1X
Username	Confirm Username
Password	Confirm Password
CA Certificate	CA certificate.
Device Certificate	device certificate.
Certification File	System's HTTPS server CA file.

9.13 Line>> SIP

Basic Settings >>

Enable Auto Answering: <input checked="" type="checkbox"/>	Auto Answering Delay: <input type="text" value="0"/> (0~120)second(s)
Enable Hotline: <input type="checkbox"/>	Hotline Number: <input type="text"/>
Hotline Delay: <input type="text" value="0"/> (0~9)second(s)	DTMF SIP INFO Mode: <input type="text" value="Send 10/11"/>
Dial Without Registered: <input type="checkbox"/>	Use VPN: <input checked="" type="checkbox"/>
DTMF Type: <input type="text" value="AUTO"/>	Signal Failback: <input type="checkbox"/>
Request With Port: <input checked="" type="checkbox"/>	Signal Retry Counts: <input type="text" value="3"/> (1~10)
Use STUN: <input type="checkbox"/>	
Enable Failback: <input checked="" type="checkbox"/>	
Failback Interval: <input type="text" value="1800"/> second(s)	

Codecs Settings >>

Disabled Codecs:

Enabled Codecs:

G.711U
G.711A
G.729AB
iLBC
opus
G.722

Advanced Settings >>

Use Feature Code: <input type="checkbox"/>	Disable Blocking Anonymous Call: <input type="text"/>
Enable Blocking Anonymous Call: <input type="text"/>	Send Anonymous Off Code: <input type="text"/>
Send Anonymous On Code: <input type="text"/>	Session Timeout: <input type="text" value="1800"/> second(s)
Enable Session Timer: <input type="checkbox"/>	Keep Alive Interval: <input type="text" value="30"/> second(s)
Response Single Codec: <input type="checkbox"/>	Blocking Anonymous Call: <input type="checkbox"/>
Keep Alive Type: <input type="text" value="UDP"/>	Enable OSRTP: <input type="checkbox"/>
Keep Authentication: <input type="checkbox"/>	Specific Server Type: <input type="text" value="COMMON"/>
RTP Encryption(SRTP): <input type="text" value="Disabled"/>	Anonymous Call Standard: <input type="text" value="None"/>
Block RTP When Alerting: <input type="checkbox"/>	Ring Type: <input type="text" value="1.wav"/>
User Agent: <input type="text"/>	Use Tel Call: <input type="checkbox"/>
SIP Version: <input type="text" value="RFC3261"/>	Enable PRACK: <input type="checkbox"/>
Local Port: <input type="text" value="5060"/>	Call-ID Format: <input type="text" value="\$id@\$ip"/>
Enable user=phone: <input type="checkbox"/>	Enable Long Contact: <input type="checkbox"/>
Auto TCP: <input type="checkbox"/>	Convert URI: <input checked="" type="checkbox"/>
Enable Rport: <input checked="" type="checkbox"/>	Enable GRUU: <input type="checkbox"/>
DNS Mode: <input type="text" value="A"/>	Enable Use Inactive Hold: <input type="checkbox"/>
Enable Strict Proxy: <input checked="" type="checkbox"/>	
Use Quote in Display Name: <input type="checkbox"/>	
Sync Clock Time: <input type="checkbox"/>	

uaCSTA Number:	<input type="text"/>	Caller ID Header:	PAI-RPID-FI <input type="button" value="?"/>
Use 182 Response for Call waiting:	<input type="checkbox"/> <input type="button" value="?"/>	Enable SCA:	<input type="checkbox"/> <input type="button" value="?"/>
Enable Feature Sync:	<input type="checkbox"/> <input type="button" value="?"/>	Enable ChangePort:	<input type="checkbox"/>
Enable Click To Talk:	<input type="checkbox"/>	VQ Server:	<input type="text"/>
VQ Name:	<input type="text"/>	VQ Http/Https server:	<input type="text"/>
VQ Server Port:	5060		
Server Expire:	<input checked="" type="checkbox"/> <input type="button" value="?"/>		
TLS Version:	TLS 1.2 <input type="button" value="?"/>		
Unregister On Boot:	<input type="checkbox"/>	Enable MAC Header:	<input type="checkbox"/>
Enable Register MAC Header:	<input type="checkbox"/>	Enable Deal 180:	<input checked="" type="checkbox"/>
PTime(ms):	Disabled <input type="button" value="?"/> millisecond	Transaction Timer T2:	4000 <input type="button" value="?"/> (2000~40000)millisecond
Transaction Timer T1:	500 <input type="button" value="?"/> (500~10000)millisecond	Enable TCP Transaction Timer:	<input type="checkbox"/>
Transaction Timer T4:	5000 <input type="button" value="?"/> (2500~60000)millisecond		
CallPark Number:	<input type="text"/> <input type="button" value="?"/>		
Intercom Number:	<input type="text"/>		

SIP Global Settings >>

Picture 23- SIP

Table 11 - SIP

Parameters	Description
Register Settings	
Line Status	Display the current line status at page loading. To get the up to date line status, user has to refresh the page manually.
Server Address	Enter the IP or FQDN address of the SIP server
Server Port	Enter the SIP server port, default is 5060
Authentication User	Enter the authentication user of the service account
Authentication Password	Enter the authentication password of the service account
Username	Enter the username of the service account.
Display Name	Enter the display name to be sent in a call request.
Activate	Whether the service of the line should be activated
Realm	Enter the SIP domain if requested by the service provider
SIP Proxy Server Address	Enter the IP or FQDN address of the SIP proxy server
Proxy Server Port	Enter the SIP proxy server port, default is 5060
Proxy User	Enter the SIP proxy user
Proxy Password	Enter the SIP proxy password
Backup Proxy Server Address	Enter the IP or FQDN address of the backup proxy server
Backup Proxy Server Port	Enter the backup proxy server port, default is 5060
Basic Settings	

Enable Auto Answering	Enable auto-answering, the incoming calls will be answered automatically after the delay time
Auto Answering Delay	Set the delay for incoming call before the system automatically answered it
Call Forward Unconditional	Enable unconditional call forward, all incoming calls will be forwarded to the number specified in the next field
Call Forward Number for Unconditional	Set the number of unconditional call forward
Call Forward on Busy	Enable call forward on busy, when the phone is busy, any incoming call will be forwarded to the number specified in the next field
Call Forward Number for Busy	Set the number of call forward on busy
Call Forward on No Answer	Enable call forward on no answer, when an incoming call is not answered within the configured delay time, the call will be forwarded to the number specified in the next field
Call Forward Number for No Answer	Set the number of call forward on no answer
Call Forward Delay for No Answer	Set the delay time of not answered call before being forwarded
Transfer Timeout	Set the timeout of call transfer process
Conference Type	Set the type of call conference, Local=set up call conference by the device itself, maximum supports two remote parties, Server=set up call conference by dialing to a conference room on the server
Server Conference Number	Set the conference room number when conference type is set to be Server
Subscribe For Voice Message	Enable the device to subscribe a voice message waiting notification, if enabled, the device will receive notification from the server if there is voice message waiting on the server
Voice Message Number	Set the number for retrieving voice message
Voice Message Subscribe Period	Set the interval of voice message notification subscription
Enable Hotline	Enable hotline configuration, the device will dial to the specific number immediately at audio channel opened by off-hook handset or turn on hands-free speaker or headphone
Hotline Delay	Set the delay for hotline before the system automatically dialed it
Hotline Number	Set the hotline dialing number
Dial Without Registered	Set call out by proxy without registration

Enable Missed Call Log	If enabled, the phone will save missed calls into the call history record.
DTMF Type	Set the DTMF type to be used for the line
DTMF SIP INFO Mode	Set the SIP INFO mode to send '*' and '#' or '10' and '11'
Enable DND	Enable Do-not-disturb, any incoming call to this line will be rejected automatically
Registration Expiration	Set the SIP expiration interval
Use VPN	Set the line to use VPN restrict route
Use STUN	Set the line to use STUN for NAT traversal
Codec Settings	Set the priority and availability of the codecs by adding or remove them from the list.
Advanced Settings	
Use Feature Code	When this setting is enabled, the features in this section will not be handled by the device itself but by the server instead. In order to control the enabling of the features, the device will send feature code to the server by dialing the number specified in each feature code field.
Enable DND	Set the feature code to dial to the server
Disable DND	Set the feature code to dial to the server
Enable Call Forward Unconditional	Set the feature code to dial to the server
Disable Call Forward Unconditional	Set the feature code to dial to the server
Enable Call Forward on Busy	Set the feature code to dial to the server
Disable Call Forward on Busy	Set the feature code to dial to the server
Enable Call Forward on No Answer	Set the feature code to dial to the server
Disable Call Forward on No Answer	Set the feature code to dial to the server
Enable Blocking Anonymous Call	Set the feature code to dial to the server
Disable Blocking Anonymous Call	Set the feature code to dial to the server
Call Waiting On Code	Set the feature code to dial to the server
Call Waiting Off Code	Set the feature code to dial to the server
Send Anonymous On Code	Set the feature code to dial to the server
Send Anonymous Off	Set the feature code to dial to the server

Code	
SIP Encryption	Enable SIP encryption such that SIP transmission will be encrypted
SIP Encryption Key	Set the pass phrase for SIP encryption
RTP Encryption	Enable RTP encryption such that RTP transmission will be encrypted
RTP Encryption Key	Set the pass phrase for RTP encryption
Enable Session Timer	Set the line to enable call ending by session timer refreshment. The call session will be ended if there is not new session timer event update received after the timeout period
Session Timeout	Set the session timer timeout period
Enable BLF List	Enable/Disable BLF List
BLF List Number	BLF List allows one BLF key to monitor the status of a group. Multiple BLF lists are supported.
Keep Alive Type	Set the line to use dummy UDP or SIP OPTION packet to keep NAT pinhole opened
Keep Alive Interval	Set the keep alive packet transmitting interval
Keep Authentication	Keep the authentication parameters from previous authentication
Blocking Anonymous Call	Reject any incoming call without presenting caller ID
User Agent	Set the user agent, the default is Model with Software Version.
Specific Server Type	Set the line to collaborate with specific server type
SIP Version	Set the SIP version
Anonymous Call Standard	Set the standard to be used for anonymous
Local Port	Set the local port
Ring Type	Set the ring tone type for the line
Enable user=phone	Sets user=phone in SIP messages.
Use Tel Call	Set use tel call
Auto TCP	Using TCP protocol to guarantee usability of transport for SIP messages above 1500 bytes
Transport Protocol	Set the line to use TCP or UDP for SIP transmission
Enable Rport	Set the line to add rport in SIP headers
Enable PRACK	Set the line to support PRACK SIP message
DNS Mode	Select DNS mode, A, SRV, NAPTR
Enable Long Contact	Allow more parameters in contact field per RFC 3840
Enable Strict Proxy	Enables the use of strict routing. When the phone receives packets from the server, it will use the source IP address, not the address in via field.
Convert URI	Convert not digit and alphabet characters to %hh hex code
Use Quote in Display	Whether to add quote in display name, i.e. "Fanvil" vs Fanvil

Name	
Enable GRUU	Support Globally Routable User-Agent URI (GRUU)
Sync Clock Time	Time Syncn with server
Caller ID Header	Set the Caller ID Header
Use 182 Response for Call waiting	Set the device to use 182 response code at call waiting response
Response Single Codec	If setting enabled, the device will use single codec in response to an incoming call request
BLF Server	The registered server will receive the subscription package from ordinary application of BLF phone. Please enter the BLF server, if the sever does not support subscription package, the registered server and subscription server will be separated.
Enable Feature Sync	Feature Syncn with server
Enable SCA	Enable/Disable SCA (Shared Call Appearance)
CallPark Number	Set the callPark number
Server Expire	
TLS Version	Choose TLS Version
PTime(ms)	Set whether to bring ptime field, default no.
Transaction Timer T1	Configure the duration of SIP transaction timer T1
Transaction Timer T2	Configure the duration of SIP transaction timer T2
Transaction Timer T4	Configure the duration of SIP transaction timer T4

9.14 Line >> SIP Hotspot

SIP hotspot is a simple and practical function. It is simple to configure, can realize the function of group vibration, and can expand the number of SIP accounts.

See [8.3 Hotspot](#) for details.

9.15 Line >> Basic Settings

STUN -Simple Traversal of UDP through NAT -A STUN server allows a phone in a private network to know its public IP and port as well as the type of NAT being used. The equipment can then use this information to register itself to a SIP server so that it can make and receive calls while in a private network.

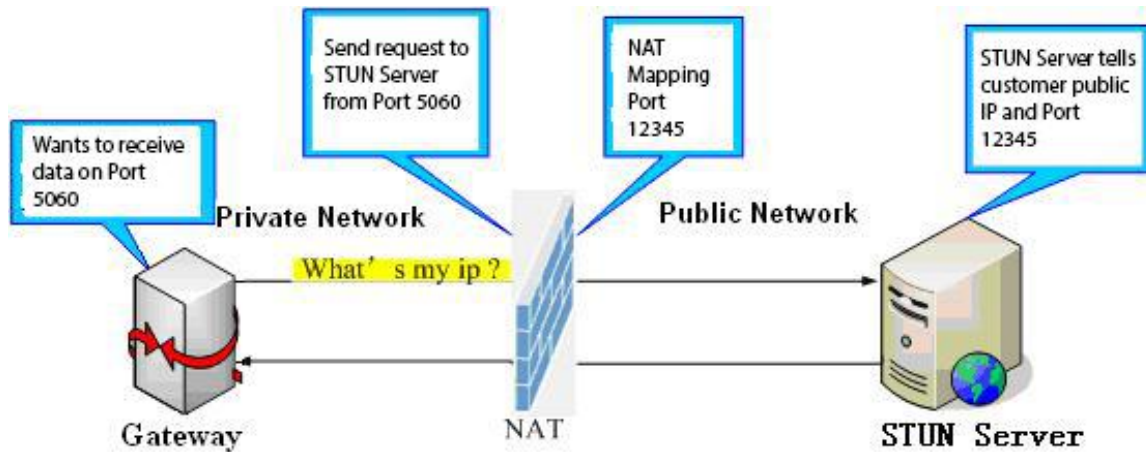

Picture 24- Basic Settings

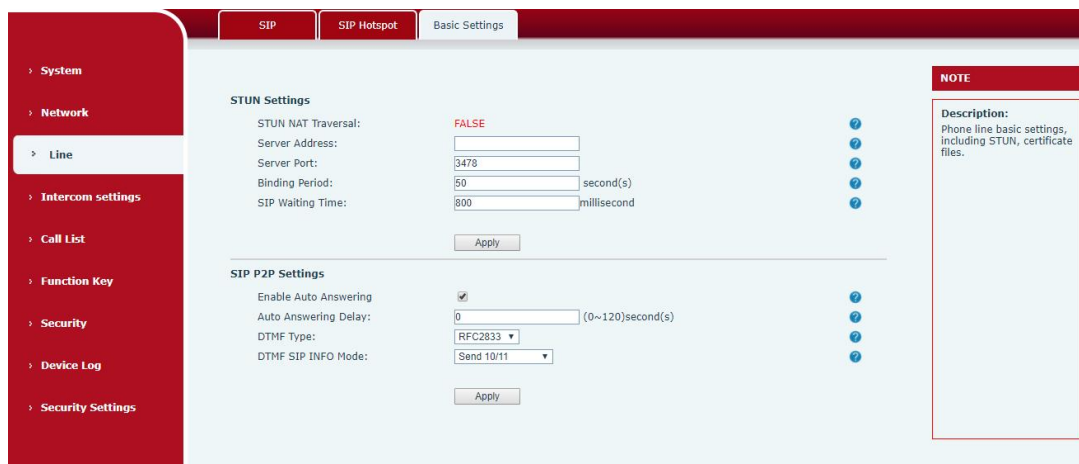

Picture 25 - Line Basic Setting

Table 12- Line Basic Setting

Parameters	Description
STUN Settings	
Server Address	Set the STUN server address
Server Port	Set the STUN server port, default is 3478
Binding Period	Set the STUN binding period which can be used to keep the NAT pinhole opened.
SIP Waiting Time	Set the timeout of STUN binding before sending SIP messages
SIP P2P Settings	
Enable Auto Answering	Automatically answer incoming IP calls after the timeout period is enabled
Auto Answering Delay	Automatic answer timeout setting
DTMF Type	Set the DTMF type of the line.

DTMF SIP INFO Mode	Set SIP INFO mode to send '*' and '#' or '10' and '11'
--------------------	--

9.16 Line>>Action Plan

When calling to a phone, the bounded IP camera synchronously transmits video to the opposite phone (video support).

Log in to the device web, visit **[Line] >[Action Plan]**, and configure action plan rules.

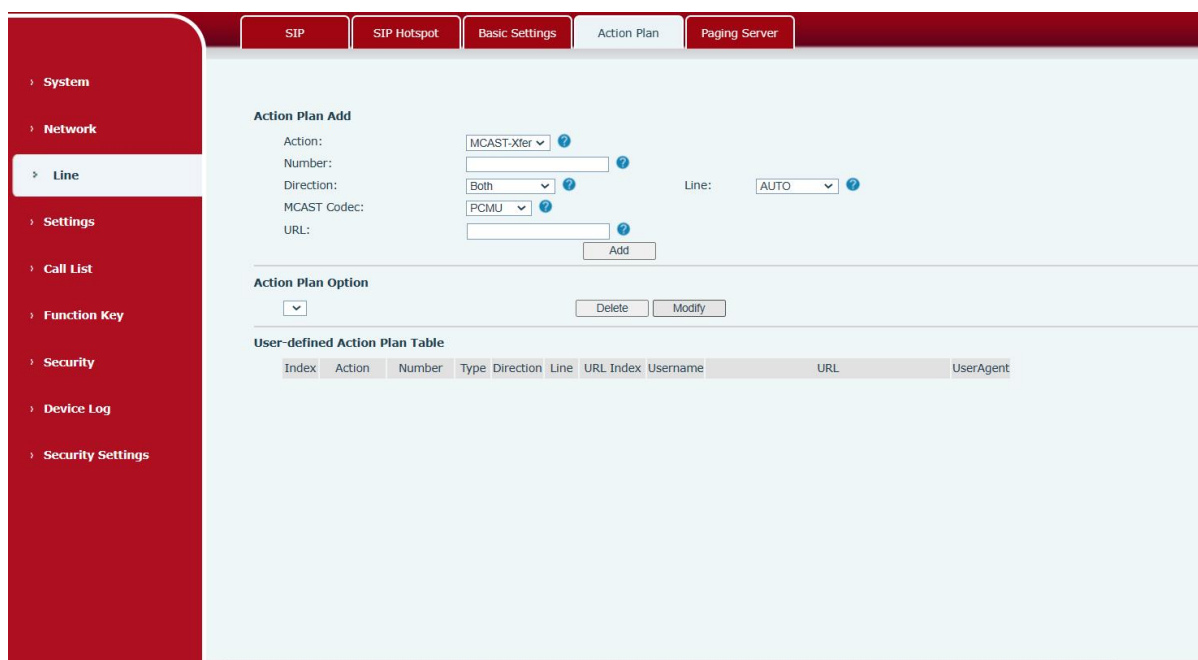

Picture 26 - Action Plan

Table 13 - Action Plan

Parameters	Description
Action	Convert multicast: When the rule is triggered, the phone converts incoming calls or multicast to multicast and sends them to the set multicast address port.
Number	The calling number corresponding to each Action Plan; The same number expression as the dial plan is supported 123; 1xx; 1.; 1[3,5,7,8]xxxxxxxxx; 5753[5-6]xxxx X means any bit match; Indicates any bit matching; [] represents a matching rule corresponding to a certain bit;

Line	The selected rule corresponds to the matching SIP line
Direction	The behavior of the corresponding configuration rule is handled Both: trigger both incoming and outgoing calls at the same time; Outgoing call: Triggered when outbound calling: Incoming call: triggered when inbound call;
MCAST Codec	Set MCAST Codec
MCAST URL	The URL corresponding to the action plan

9.17 Settings >> Features

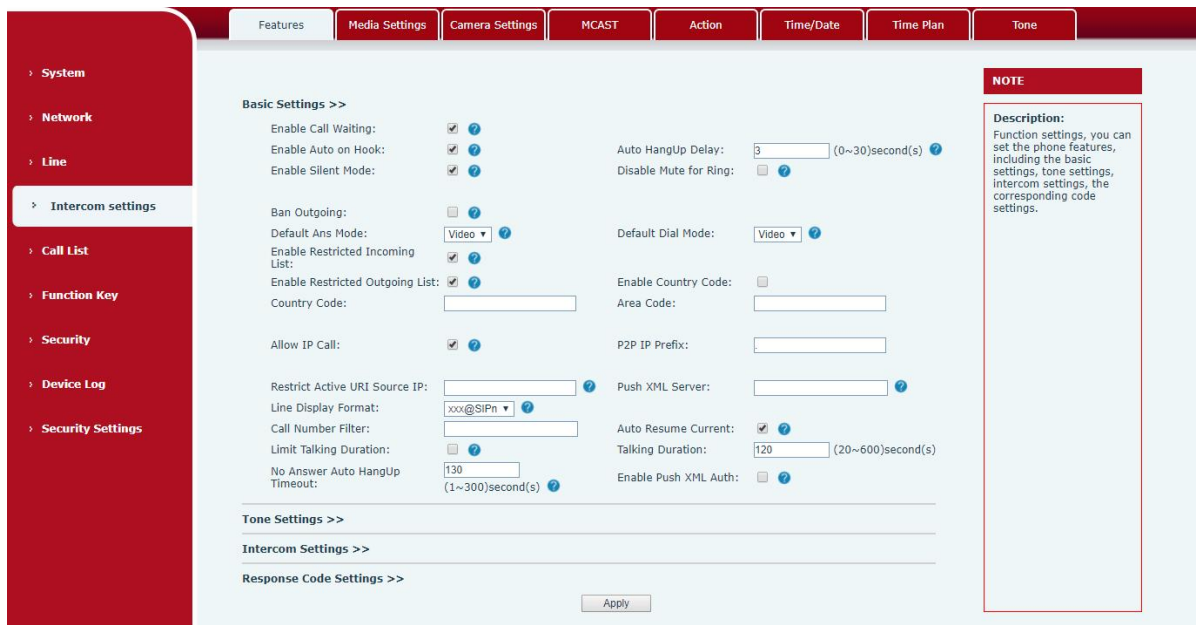

Picture 27 - Feature

Table 14- Common device function Settings on the web page

Parameters	Description
Basic Settings	
Enable Call Waiting	Enable this setting to allow user to take second incoming call during an established call. Default enabled.
Enable Auto on Hook	The device will hang up and return to the idle automatically at hands-freemode.
Auto HangUp Delay	Specify Auto Onhook time, the device will hang up and return to the idle automatically after Auto Hand down time at hands-free mode, and play dial tone Auto Onhook time at handset mode.

Auto HangUp Tone	Enable auto hang up tone to play tone after peer hangs up
Enable Silent Mode	When enabled, the phone is muted, there is no ringing when calls, you can use the volume keys and mute key to unmute.
Disable Mute for Ring	When it is enabled,you can not mute the phone.
Ban Outgoing	If you select Ban Outgoing to enable it, and you cannot dial out any number.
Enable Restricted Incoming List	Whether enable Restricted Incoming List
Enable Restricted Outgoing List	Wether enable Restricted Outgoing List
Enable country Code	Wether enable country Code
Country Code	Country Code
Area Code	Area Code
Allow IP Call	If enabled, user can dial out with IP address
P2P IP Prefix	You can set IP call prefix,for example,i set it as "172.16.2.",then i input #160 in dialpad and press dial key ,it will call 172.16.2.160 automatically
Disable AEC	Enable or disable AEC functionality
Restrict Active URI Source IP	Set the device to accept Active URI command from specific IP address.
Push XML Server	Configure the Push XML Server, when phone receives request, it will determine whether to display corresponding content on the phone which sent by the specified server or not.
Line Display Format	Line display format including SIPn/SIPn: xxx/xxx@SIPn
Block XML When Call	Blocked Push XML When Call
SIP Notify	when enabled, when the phone receives relevant notify content, the corresponding information will be displayed.
Call Number Filter	Configure a special character & ,if the number is 78 & 9. The call will be filtered out&
Auto Resume Current	If the current path changes, the hold will be automatically resume
Limit Talking Duration	Automatically hang up the call after enabling the time set for the call
Talking Duration	Call duration ,20-600s
Call Timeout	The remote phone does not answer within the time, the local automatically hangs up
No Answer Auto HangUp Timeout	If the call is not answered, the call will be automatically hung up after the timeout
Enable Push XML Auth	To enable push xml auth, user password is required
Tone Settings	
Enable Holding Tone	When turned on, a tone plays when the call is held

Enable Call Waiting Tone	When turned on, a tone plays when call waiting
Play Dialing DTMF Tone	Play DTMF tone on the device when user pressed a phone digits at dialing, default enabled.
Play Talking DTMF Tone	Play DTMF tone on the device when user pressed a phone digits during taking, default enabled.
Enable Http Api Auth	Enable HttpApi authentication push xml
Http API UserName	Set the Http API username
Http Api PassWord	Set the HTTP API password
Description	Sets the description information displayed
Tone Settings	
Enable Holding Tone	whether enable call holding tone.
Enable Call Waiting Tone	whether enable call waiting tone.
Play Dialing DTMF Tone	Play DTMF tone on the device when user pressed a phone digit at dialing, default enabled
Play Talking DTMF Tone	Play DTMF tone on the device when user pressed a phone digits during taking, default enabled
Ring Back Tone	When the user is on a call, use a custom-set ringback tone
Busy Tone	When the user hangs up at the end of the call, use the custom-set wake tone
Intercom Settings	
Enable Intercom	When intercom is enabled, the device will accept the incoming call request with a SIP header of Alert-Info instruction to automatically answer the call after specific delay.
Enable Intercom Mute	Enable mute mode during the intercom call
Enable Intercom Tone	If the incoming call is intercom call, the phone plays the intercom tone
Enable Intercom Barge	Enable Intercom Barge by selecting it, the phone auto answers the intercom call during a call. If the current call is intercom call, the phone will reject the second intercom call
Response Code Settings	
Busy Response Code	Set the SIP response code on line busy
Reject Response Code	Set the SIP response code on call rejection

9.18 Settings >> Noise Reduction

Different levels of noise reduction technology can be configured, supporting intelligent noise reduction. When activated, it can effectively reduce noise, making calls clearer.

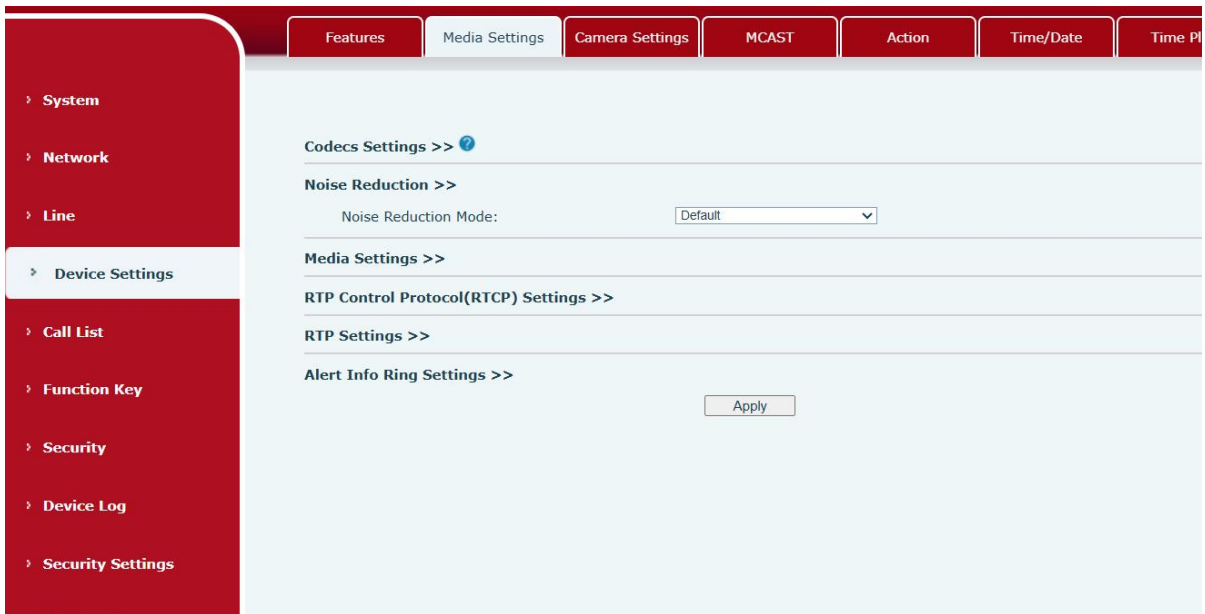

9.19 Settings >> Media Settings

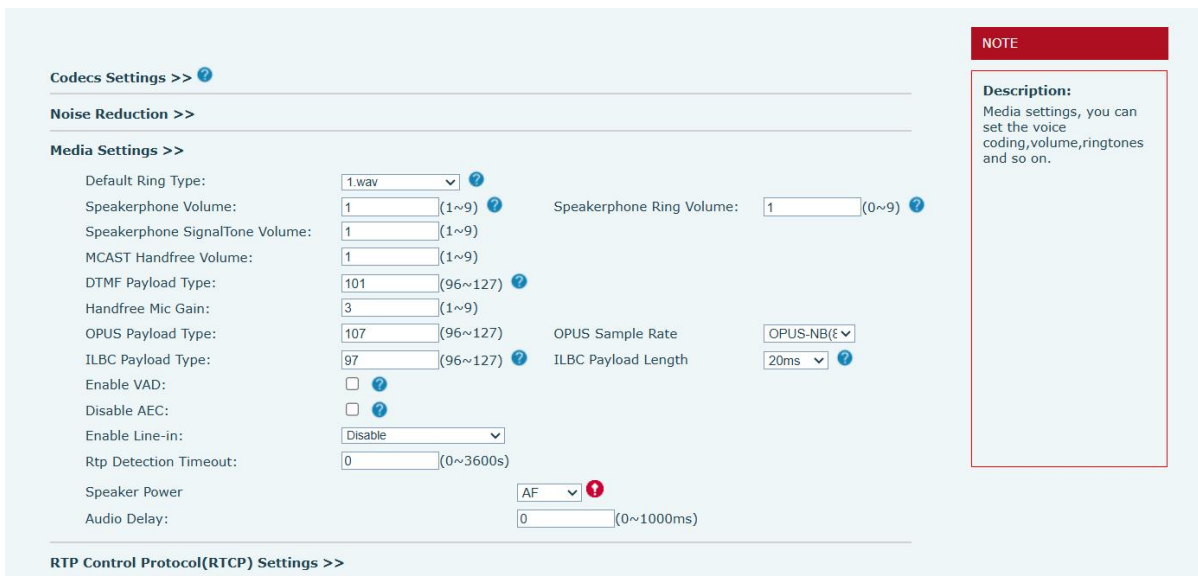

Picture 28- Media Settings

Table 15- Media Settings

Parameters	Description
Codecs Settings	Select the enabled and disabled voice codecs codec:G.711A/U,G.722,G.723,G.729AB,G.726-32, ILBC,opus
Noise Reduction	Select the noise reduction level, configure it as intelligent noise reduction, it can effectively isolate noise.
Audio Settings	

Default Ring Type	Set the default ring type. If the caller ID of an incoming call was not configured with specific ring type, the default ring will be used.
Speakerphone Volume	Set the speakerphone volume, the value must be 1~9
Speakerphone Ring Volume	Set the ring volume in the speakerphone, the value must be 0~9
Speakerphone SignalTone Volume	Set the SignalTone Volume in the speakerphone, the value must be 1~9
DTMF Payload Type	Enter the DTMF payload type, the value must be 96~127.
Handfree Mic Gain	Set Handfree Mic Gain, the value must be 1~9
Opus payload type	Enter the opus payload type, the value must be 96~127.
OPUS Sample Rate	Set the opus sample rate , including OPUS-NB (8KHz), OPUS-WB (16KHz)
ILBC Payload Type	Set the ILBC Payload Type
ILBC Payload Length	Set the ILBC Payload Length
Enable VAD	Enable Voice Activity Detection. When enabled, the device will suppress the audio transmission with artificial comfort noise signal to save the bandwidth.
Audio Delay	When multicast is enabled, set the delay time for audio playback to facilitate audio playback by multiple devices.
Speaker Power	
RTP Control Protocol(RTCP) Settings	
CNAME user	Set the CNAME user
CNAME host	Set the CNAME host
RTP	
RTP keep alive	Keep talking, send a packet 30 seconds after enable it
Alert Info Ring Settings (alert-info)	
Value of notification message 1 to 10	Set the value of the specified ring type
ring type	The ring type

9.20 Settings>>Camera Settings

Customers can use it to configure camera-related parameters and adjust video encoding related settings.

Connection mode setting

Camera Status:
 Connect Mode:

IP Camera Add

Name: ?
 Username: ?
 Password: ?
 Ip Camera Brand: ?
 IP:
 Port:
 UserAgent: ?
 URL1:
 URL2:

IP Camera Option

IP Camera List

Index	Name	Username	UserAgent	URL	Status
-------	------	----------	-----------	-----	--------

[Advanced Settings >>](#)

Picture 29- Camera Settings

Table 16- Camera Settings

Parameters	Description
Connection mode setting	
Camera Status	
Connect Mode	Set the connection mode of the camera, only external cameras are supported
IP Camera Add	
Name	Set the camera name
Username	The username that is authenticated when accessing the URL
Password	The password that is authenticated when accessing the URL
Ip Camera Brand	Set the camera brand
IP	Set the IP address of the camera
Port	Set the port for the camera
UserAgent	The user agent parameter that is carried when accessing the URL
IP Camera List	
Video Direction	Set the video direction to Send Only, Receive Only, or Send and Receive
H.264 Payload Type	Set the H.264 load type

9.21 Settings >> MCAST

It is easy and convenient to use multicast function to send notice to each member of the multicast via setting the multicast key on the device and sending multicast RTP stream to pre-configured multicast address. By configuring monitoring multicast address on the device, monitor and play the RTP stream which sent by the multicast address.

The detail for [8.2 MCAST](#)

9.22 Settings >> Action

Table 17- Action URL

Action URL Event Settings
Set URL for the device to report its action to server. These actions are recorded and sent as xml files to the server. Sample format is http://InternalServer /FileName.xml. (Internal Server: The IP address of server; File Name: the device's xml file used to report action.)

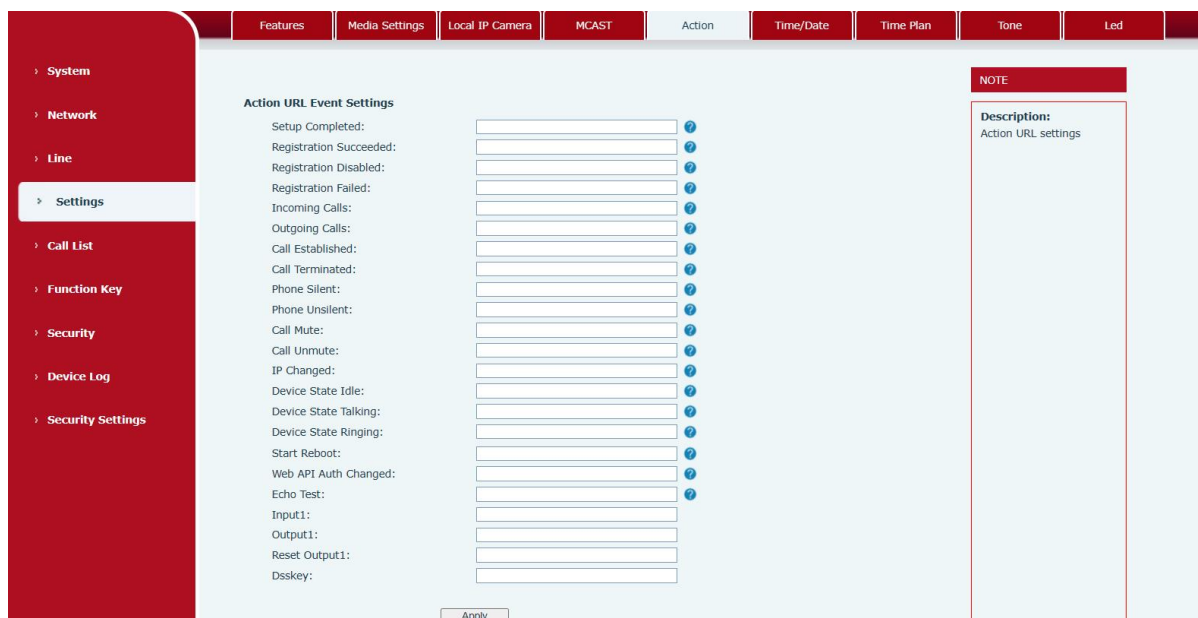

Picture 30- Action URL

9.23 Settings >> Time/Date

Users can configure the device's time Settings on this page.

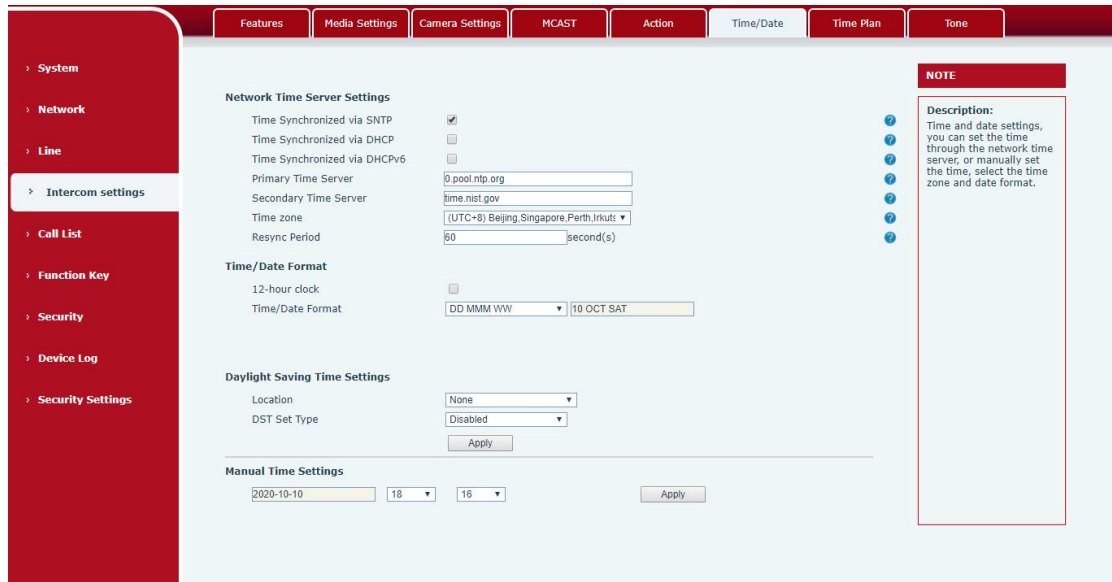

Picture 31 - Time/Date

Table 18- Time/Date

Time/Date	
Field Name	Explanation
Network Time Server Settings	
Time Synchronized via SNTP	Enable time-sync through SNTP protocol
Time Synchronized via DHCP	Enable time-sync through DHCP protocol
Primary Time Server	Set primary time server address
Secondary Time Server	Set secondary time server address, when primary server is not reachable, the device will try to connect to secondary time server to get time synchronization.
Time zone	Select the time zone
Resync Period	Time of re-synchronization with time server
Daylight Saving Time Settings	
Location	Select the user's time zone specific area
DST Set Type	Select automatic DST according to the preset rules of DST, or the manually input rules
Offset	The DST offset time
Month Start	The DST start month
Week Start	The DST start week
Weekday Start	The DST start weekday
Hour Start	The DST start hour
Month End	The DST end month

Week End	The DST end week
Weekday End	The DST end weekday
Hour End	The DST end hour
Manual Time Settings	
To set the time manually, you need to disable the SNTP service first, and you need to fill in and submit each item of year, month, day, hour and minute in the figure above to make the manual settings successful.	
System time: Display system time and its source (SIP automatic get >SNTP automatic get >manual manual setting)	

9.24 Settings>>Time plan

The user can set the time point and time period for the device to perform a certain action.

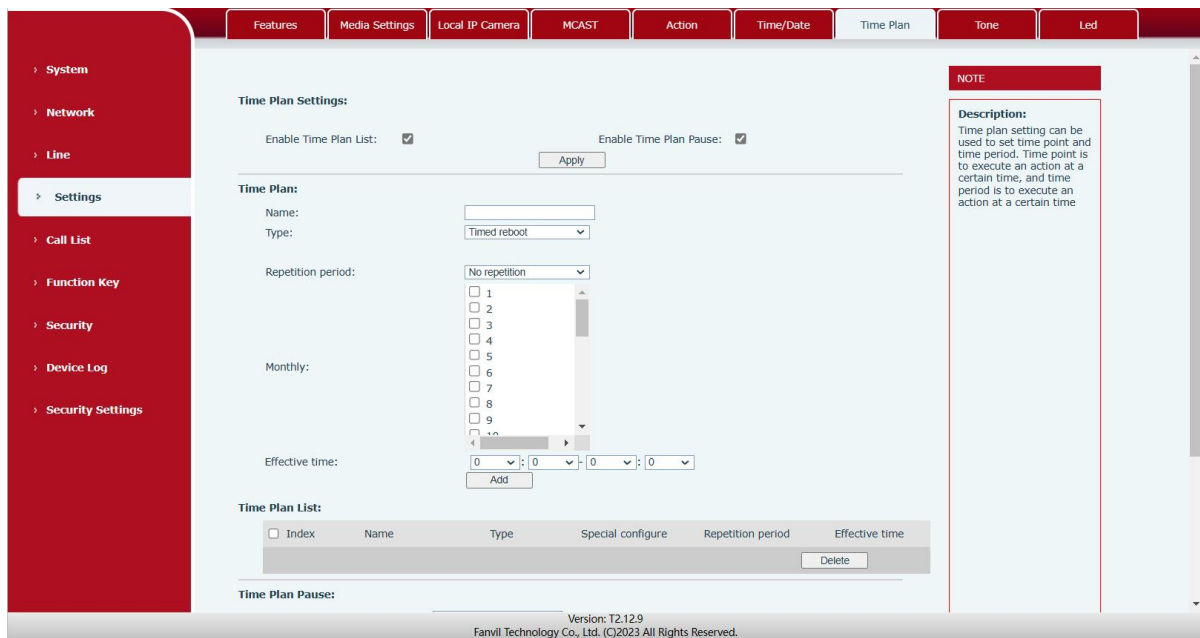

Picture 32- Time Plan

Table 19- Time Plan

Parameters	Description
Time Plan Settings	
Enable Time Plan List	Turn on the time management list, and then perform the set action at the set time period
Enable Time Plan Pause	Turn on the pause list, and the device will not perform the set action until the time of setting pause
Time Plan	

Name	Enter a custom name
Type	Timed reboot, Timed upgrade, Timed echo test, Timed play audio ,Timed config
Audio Path	Support on-premises Local: Select the locally uploaded audio file
Play mode	When the type is selected as Play Audio, it supports setting to loop playback or play it once
Play Type	Local: The device plays audio Multicast: The device sends audio over multicast Local & Multicast: While the device plays locally, it also sends audio through multicast
Multicast address	Sets the multicast address when playing audio
Code	The encoding used when multicast audio
Repetition period	No repetition: Execute once within the set time range Daily: Perform this operation in the same time range every day Weekly: Do this within the time range of the day of the week Monthly: Perform this operation within the time range of the day of each month
Effective time	Set the execution period
Time Plan List	
Time Plan Pause	
Name	Pause list name
Start time	Set start time
Stop time	Set stop time
Time Plan Pause List	

9.25 Settings >> Tone

The user can configure the prompt tone of the device on this page.

You can select the country area or customize the area. The selected area can directly appear the default information, and the customized one can modify the key tone, callback tone and other information.

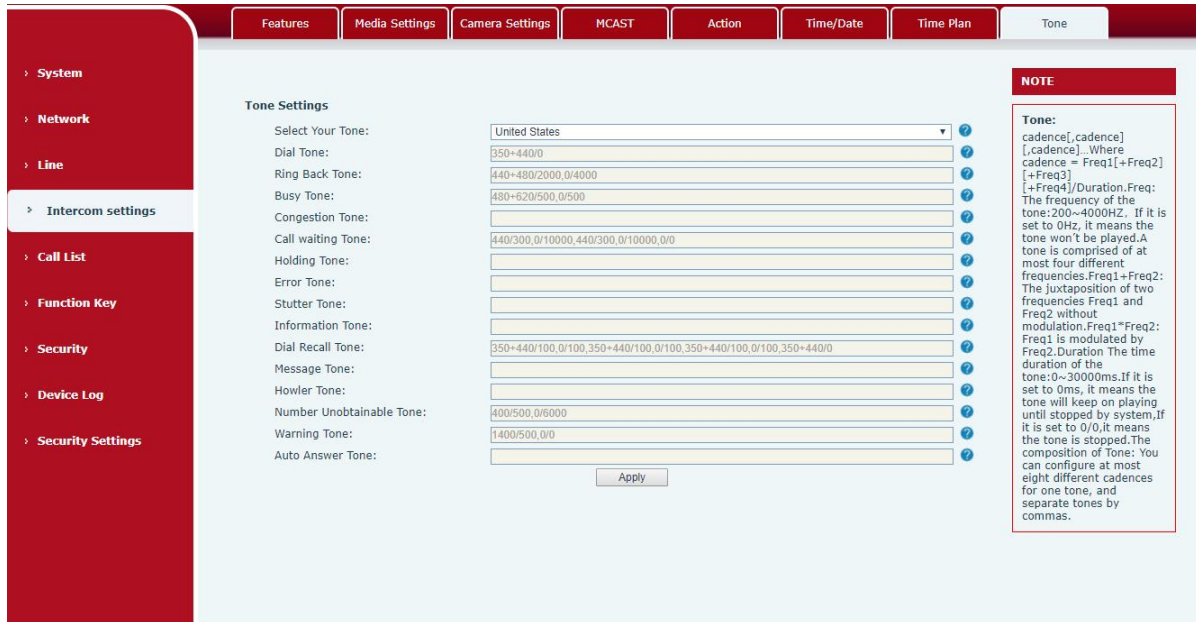

Picture 33- Tone

9.26 Call list >> Call List

■ Restricted Incoming Calls

It same as blacklist.By adding a number into the blacklist, user will no longer receive phone call from that number and it will be rejected automatically by the device until user delete it from the blacklist.

User can add specific number to be blocked, or a prefix where any numbers matched the prefix will all be blocked.

■ Restrict Outgoing Call

You can set the rule to restrict some numbers from dialing out,until you remove the number from the table.

9.27 Call list >> Web Dial

Use web page to call, answer and hang up.

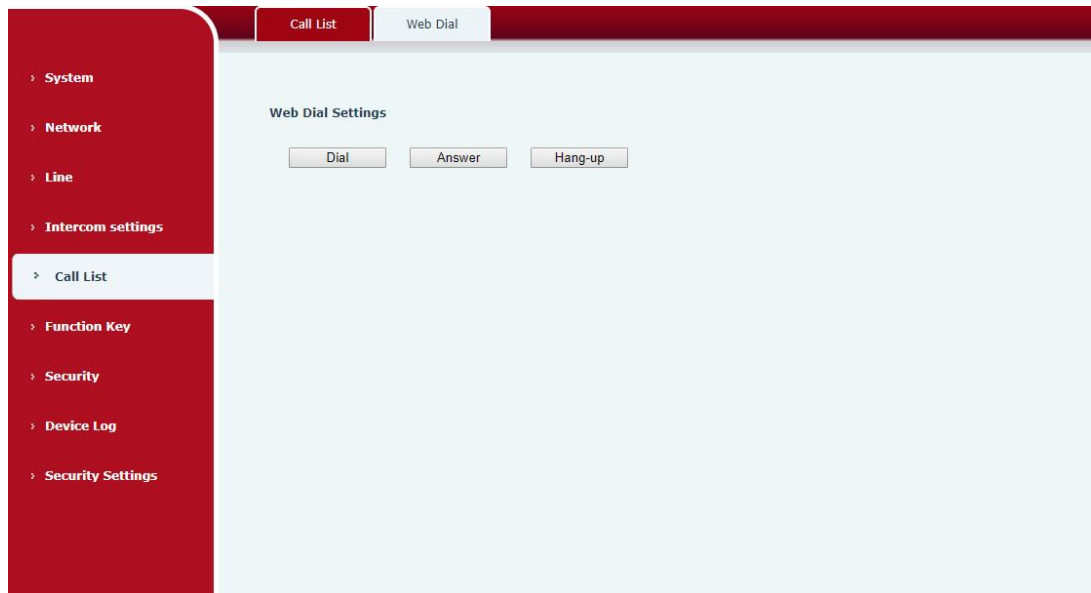

Picture 34- Webpage Dial

9.28 Function Key

Function Key Settings >>

Key	Type	Name	Value		Subtype	Line	Media	
DSS Key 1	None			+	-	None	AUTO	DEFAULT
DSS Key 2	Key Event			+	-	Handfree	AUTO	DEFAULT
DSS Key 3	None			+	-	None	AUTO	DEFAULT

Programmable Key Settings ? >>

Key	Desktop	Dialer	Ringing	Alerting	Talking	Desktop Long Pressed
Key1	Dsskey1	Dsskey1	Answer	End	End	Main Menu
Key2	Dsskey2	Dsskey2	Answer	End	End	Invalid
Key3	Dsskey3	Dsskey3	Answer	End	End	Invalid

Advanced Settings >>

Dial Mode Select:

Call Switched Time: (5~50)second(s)

First Number Start Time: (00:00~23:59) First Number End Time: (00:00~23:59)

Picture 35- Function Key

Table 20- Function Key

Parameters	Description
------------	-------------

Function key settings	
memory	<p>Speed Dial:The user can directly dial the set number. This feature is convenient for customers to dial frequent numbers.</p> <p>Intercom: This feature allows the operator or secretary to quickly connect to the phone, widely used in office environments</p>
Key event	The user can select a function key as a shortcut to trigger an event for example: None /Handfree
DTMF	Press during a call to send the set DTMF
Mcast Paging	Configure the multicast address and voice encoding. User can initiate multicast by pressing this key
Action URL	The user can use a specific URL to make basic calls to the device, open the door, etc.
Mcast Listening	In standby, press the function key, if the RTP of the multicast is detected, the device will monitor the multicast
PTT	<p>Speed dial: Make a call when pressed, and end the call when lifted.</p> <p>Intercom: Start the intercom when pressed, and end the intercom when lifted.</p> <p>Multicast: Initiate multicast when pressed, and end multicast when lifted</p>
Programmable Key Settings	
Desktop	<p>None: Nothing happens when you press the Call button</p> <p>Dsskey1: When it is set to dsskey1, follow the settings of dsskey1 to make call, answer, etc.</p> <p>Dsskey2: When it is set to dsskey2, perform operations such as calling and answering according to the setting of dsskey2</p> <p>Dsskey3: When it is set to dsskey3, perform operations such as calling and answering according to the setting of dsskey3</p>
Dialer	<p>None: Nothing happens when you press the Call button</p> <p>Dsskey1: When it is set to dsskey1, follow the settings of dsskey1 to make call, answer, etc.</p> <p>Dsskey2: When it is set to dsskey2, perform operations such as calling and answering according to the setting of dsskey2</p> <p>Dsskey3: When it is set to dsskey3, perform operations such as calling and answering according to the setting of dsskey3</p>
Ringling	<p>Answer: Set to answer, when there is an incoming call, if auto answer is disabled, press the Call button to answer the call</p> <p>End: set to end, when there is an incoming call, press the Call button to hang up the call</p>
Talking	End: set to end, when there is a call, press the Call button to hang up the

		<p>call</p> <p>Volume up: set as volume up button, when there is a call, press the Call button to increase the volume</p> <p>Volume down: set as volume up button, when there is a call, press the Call button to decrease the volume</p> <p>Dsskey1: When it is set to dsskey1, follow the settings of dsskey1 to make call, answer, etc.</p> <p>Dsskey2: When it is set to dsskey2, perform operations such as calling and answering according to the setting of dsskey2</p> <p>Dsskey3: When it is set to dsskey3, perform operations such as calling and answering according to the setting of dsskey3</p>
Desktop Pressed	Long	<p>None: Long press the Call button does not respond</p> <p>Main menu: Long press the Call button to enter the command line mode, see 5.2.1 Common Command Mode for details</p>
Advanced Settings		
Hot Key Dial Mode Select		<p>Number 1 call number 2 mode selection.</p> <p><Main/Secondary>: If the first number is not answered within the set time, the second number will be automatically switched.</p> <p><Day/Night>: The system time is automatically detected during the call. If it is daytime, the first number is called, otherwise the second number is called.</p>
Call Switched Time		Set number 1 to call number 2 time, default 16 seconds
Day Start Time		The start time of the day when the <Day/Night> mode is defined. Default "06:00"
Day End Time		The end time of the day when the <Day/Night> mode is defined. Default "18:00"

➤ Memory

Enter the phone number in the input box. When you press the function key, the device will call out the set phone number. This button can also be used to set the IP address, press the function key to make an IP direct call.

Function Key Settings >>

Key	Type	Name	Value			Subtype	Line	Media
DSS Key Left	None			+	-	None	SIP1	DEFAULT
DSS Key Middle	Memory Key			+	-	Speed Dial	SIP1	DEFAULT
DSS Key Right	None			+	-	None	AUTO	DEFAULT
Short circuit input	None			+	-	None	AUTO	DEFAULT

Programmable Key Settings ? >>

Advanced Settings >>

Picture 36 - Memory Key

Table 21- Memory Key

Type	number	line	Subtype	usage
memory	Fill in the SIP account or IP address of the called party	The line corresponding to the SIP account	Speed Dial	Using the speed dial mode, press the button to quickly dial the set number.
			Intercom	Using the intercom mode, when the SIP phone at the opposite end supports the intercom function, the call can be automatically answered.

➤ Multicast

Multicast function is to deliver voice streams to configured multicast address; all equipment monitored the multicast address can receive and play the broadcasting. Using multicast functionality would make deliver voice one to multiple which are in the multicast group simply and conveniently.

The DSS Key multicast web configuration for calling party is as follow:

Function Key Settings >>

Key	Type	Name	Value			Subtype	Line	Media
DSS Key Left	None			+	-	None	SIP1	DEFAULT
DSS Key Middle	MCAST Paging			+	-	G.711U	SIP1	Remote Only
DSS Key Right	None			+	-	None	AUTO	DEFAULT
Short circuit input	None			+	-	None	AUTO	DEFAULT

Programmable Key Settings ? >>

Advanced Settings >>

Picture 37- Multicast

Table 22- Web Multicast

Type	Number	Subtype
Multicast	Set the host IP address and port number, they must be separated by a colon (The IP address range is 224.0.0.0 to 239.255.255.255, and the port number is preferably set between 1024 and 65535)	G.711A
		G.711U
		G.729AB
		iLBC
		opus
		G.722

➤ **PTT**

Keep pressing the shortcut key set to make a call, release it and hang up

Function Key Settings >>

Key	Type	Name	Value			Subtype	Line	Media
DSS Key Left	None	<input type="text"/>	<input type="text"/>	+	-	None	SIP1	DEFAULT
DSS Key Middle	PTT	<input type="text"/>	<input type="text"/>	+	-	Speed Dial	SIP1	DEFAULT
DSS Key Right	None	<input type="text"/>	<input type="text"/>	+	-	None	AUTO	DEFAULT
Short circuit input	None	<input type="text"/>	<input type="text"/>	+	-	None	AUTO	DEFAULT

Programmable Key Settings ⓘ >>

Advanced Settings >>

Picture 38 - Advanced Setting

9.29 Security >> Web Filter

Users can set up to allow only a certain network segment IP to access the device

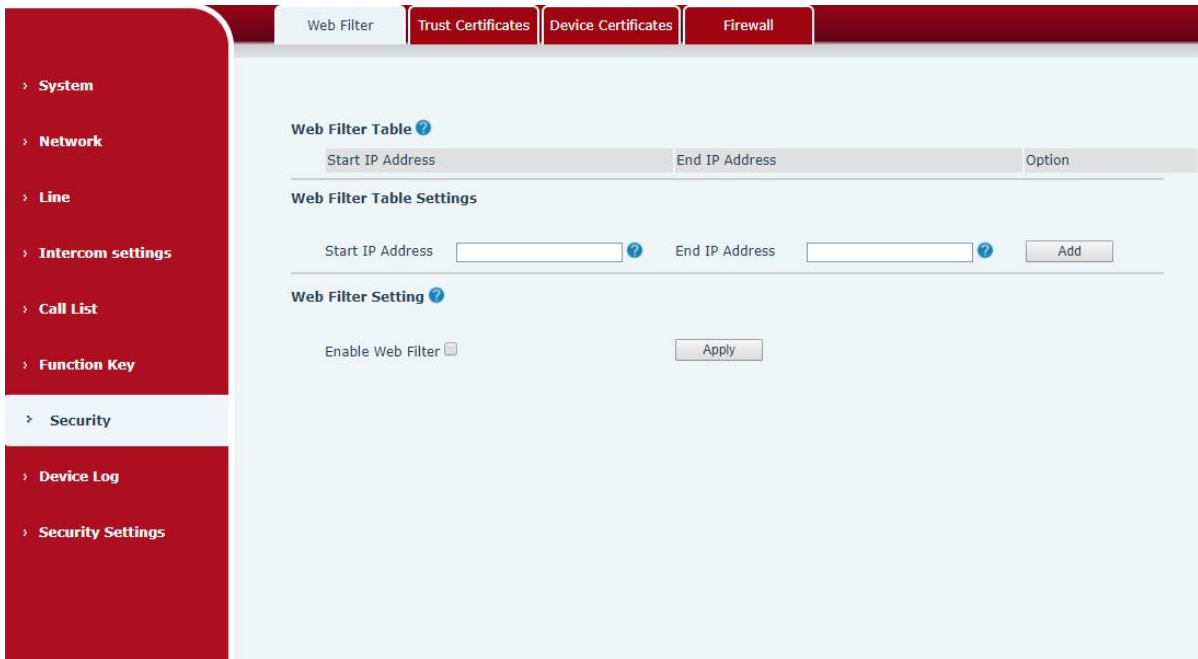

Picture 39- WEB filter

Add and delete the allowed IP network segments; configure the start IP address in the start IP, configure the end IP address in the end IP, and then click [Add] to add successfully. You can set a large network segment or add it into several network segments. When deleting, select the starting IP of the network segment to be deleted in the list, and then click [Delete] to take effect.

Enable web filtering: configure to enable/disable web access filtering; click the [Submit] button to take effect

Note: *If the device you access to the device is on the same network segment as the device, do not configure the web filtering network segment to be outside your own network segment, otherwise you will not be able to log in to the web page.*

9.30 Security >> Trust Certificates

You can upload and delete uploaded trust certificates.

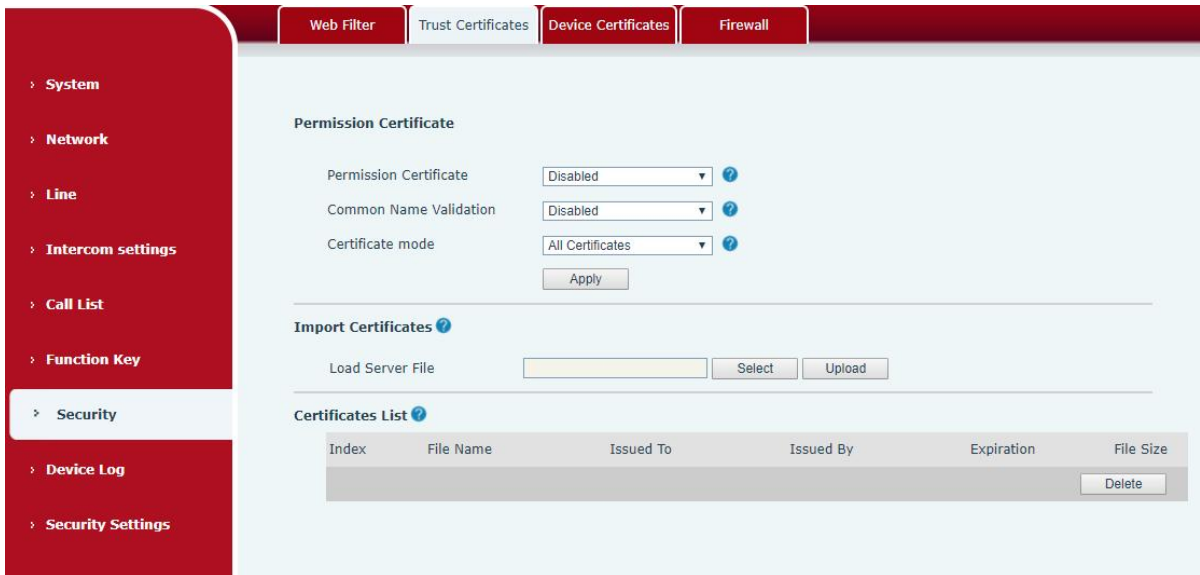

Picture 40 - Trust Certificates

9.31 Security >> Device Certificates

Select the default certificate or the custom certificate as the device certificate.
 You can upload and delete uploaded certificates.

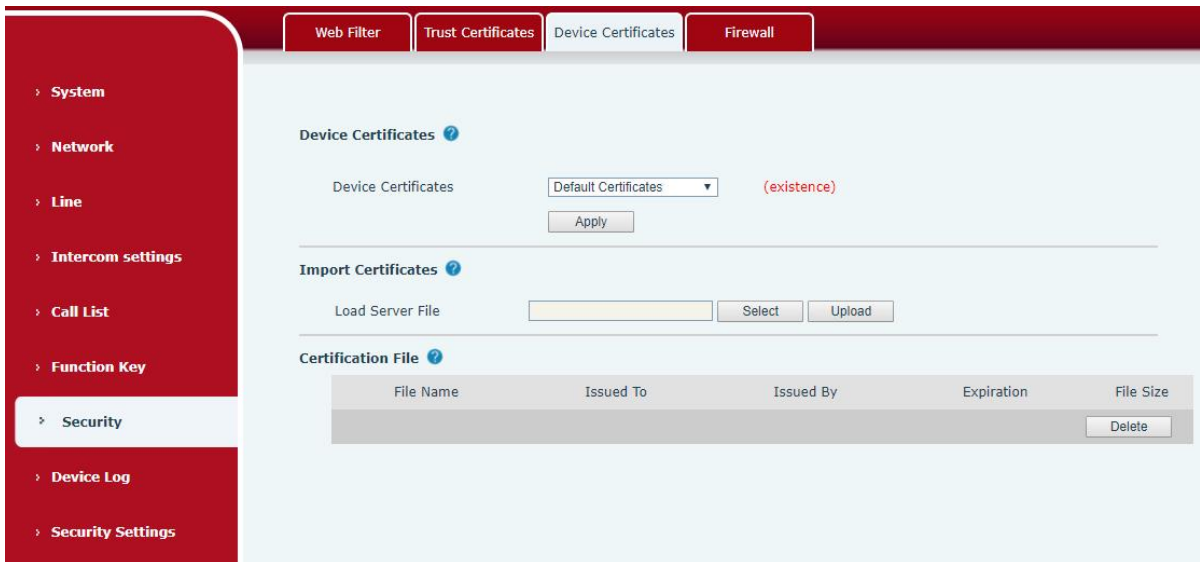

Picture 41- Device Certificates

9.32 Security >> Firewall

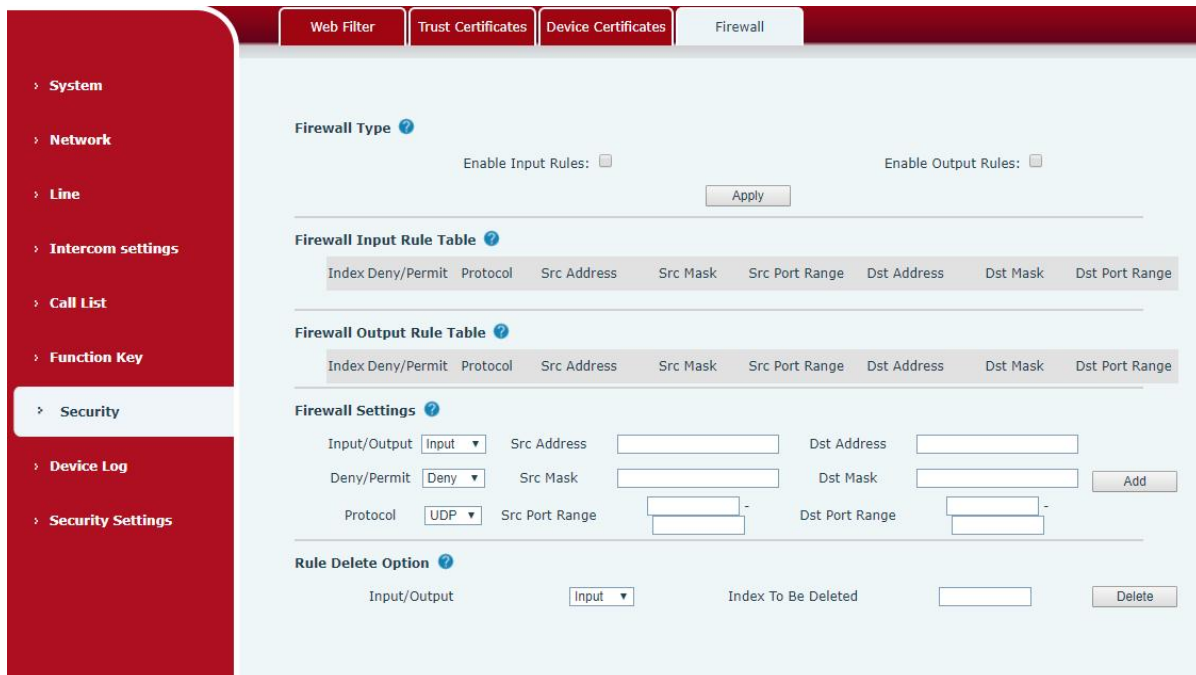

Picture 42 - Firewall

Through this page, you can set whether to enable the input and output firewalls, and at the same time, you can set the input and output rules of the firewall. Use these settings to prevent malicious network access, or restrict internal users from accessing some resources of the external network, and improve safety.

The firewall rule setting is a simple firewall module. This function supports two kinds of rules: input rules and output rules. Each rule will be assigned a serial number, and a maximum of 10 each rule can be set.

Taking into account the complexity of firewall settings, the following will illustrate with an example:

Table 23- Web Firewall

Parameter	Description
Enable Input Rules	whether enable Input Rules
Enable Output Rules	Whether enable Output Rules
input/output	Select the current rule as an input or output rule
Deny/permit	Choose the current rule is deny or allowed;
protocol	There are four types of protocols: TCP, UDP, ICMP, IP。
Port range	Port range
Src Address	The source address can be the host address, network address, or

	all addresses 0.0.0.0; it can also be a network address similar to *.*.*.0, such as 192.168.1.0.
Dst Mask	The destination address can be a specific IP address or all addresses 0.0.0.0; it can also be a network address similar to *.*.*.0, such as 192.168.1.0.
Src Port Range	It is the source address mask. When it is configured as 255.255.255.255, it means it is a specific host. When it is set as a subnet mask of type 255.255.255.0, it means that the filter is a network segment;
Dst Port Range	It is the destination address mask. When it is configured as 255.255.255.255, it means it is a specific host. When it is set as a subnet mask of 255.255.255.0 type, it means that a network segment is filtered;

After setting, click [Add], a new item will be added to the firewall output rules, as shown in the figure below:

Index	Deny/Permit	Protocol	Src Address	Src Mask	Src Port Range	Dst Address	Dst Mask	Dst Port Range
-------	-------------	----------	-------------	----------	----------------	-------------	----------	----------------

Picture 43- Firewall rules list

Then select and click the button [Submit].

In this way, when the device runs: ping 192.168.1.118, it will not be able to send data packets to 192.168.1.118 because of the prohibition of the output rule. But ping other IPs in the 192.168.1.0 network segment can still receive the response packets from the destination host normally.

Rule Delete Option

Input/Output: Index To Be Deleted:

Picture 44- Delete firewall rules

Select the list you want to delete and click [Delete] to delete the selected list.

9.33 Device Log

You can crawl the device log, when you encounter unusual problems, please send the device log to the technical staff for positioning problem. For more detail [10.5 get device log](#).

9.34 Security Settings

Enable Tamper: after enable, when the device is removed by force, the alarm information will be sent to the server and the alarm ring will be played.

Picture 45 - Security Settings

Table 24- Security Settings

Security Settings	
Parameters	Description
Basic Settings	
Ringtone Duration	Set the ringtone duration, default value is 5 seconds.
Input & Tamper Server Address	Set remote server address. The device will send message to the server when the alarm is triggered. The message format is : Alarm_Info:Description=A201;SIP User=;Mac=0c:38:3e:3a:06:65;IP=; port=Input .
Input settings	
Input Detect	Enable or disable Input Detect
Triggered by	When choosing the low level trigger (closed trigger), detect the input port (low level) closed trigger.
	When choosing the high level trigger (disconnect trigger), detect the input port (high level) disconnected trigger.

Input Duration	Set input duration
Triggered Action	<p>Send SMS: Set the alert message send to server if selected.</p> <p>Dss Key: The device will perform corresponding Dss Key configurations if any key is selected, by default the value is none.</p> <p>Triggered Ringtone: Select triggered ring tone.</p>
Output Settings	
Output Response	Enable or disable Output Response
Triggered by DTMF Ring tone	Select the DTMF trigger ring tone.
Triggered by URI Ringtone	Select the URI trigger ring tone.
Triggered By SMS Ringtone	Select the SMS trigger ring tone.
Triggered By Dsskey Ringtone	Select the Dsskey trigger ring tone.
Standard Status	When choosing the low level trigger (NO: normally open), when meet the trigger condition, trigger the NO port disconnected.
	When choosing the high level trigger (NC: normally close), when meet the trigger condition, trigger the NC port close.
Output Duration	Set the output change duration time, the default is 5 seconds.
Trigger by DTMF	Enable or disable trigger by DTMF. The device will check the received DTMF sent by remote device, if it matches the DTMF trigger code, the device will trigger corresponding output port.
DTMF Trigger Code	Input the DTMF trigger code, default value is 1234.
DTMF Reset Code	Input the DTMF reset code, default value is 4321.
Reset By	<p>Reset the output port mode by duration or state.</p> <p>By duration: Reset the output port status when output duration occurs.</p> <p>By state: Reset the output port status when device's call state changes.</p>
Trigger by URI	<p>Enable or disable trigger by URI.</p> <p>User can send commands from remote device or server to A201 series device, if the command is correct, then device will trigger corresponding output port.</p>
Trigger Message	Input trigger message for trigger by URI mode.
Rest Message	Input reset message for trigger by URI mode.
Trigger by SMS	<p>Enable or disable trigger by SMS.</p> <p>User can send ALERT command to A201 series device, if the command is correct, then device will trigger corresponding output port.</p>

Trigger SMS	Input trigger message for trigger by SMS mode.
Reset SMS	Input reset message for trigger by SMS mode.
Trigger by Input	Select the input port, when the input port meets the trigger condition, the output port will be triggered (The Port level time change, By < Output Duration > control)
Trigger By Call state	Select call state to trigger the output port, options are: Talking: When the device's talking status changes, trigger the output port. Ringing: When the device's ringing status changes, trigger the output port. Calling: When the device's calling status changes, trigger the output port.
Trigger By DssKey	Enable or disable trigger by dsskey. If any of the dsskey is selected, when the dsskey application performs, the output port will be triggered.

10 Trouble Shooting

When the device is not working properly, users can try the following methods to restore the device to normal operation or collect relevant information to send a problem report to the Fanvil technical support mailbox.

10.1 Get Device System Information

Users can obtain information through the **[System]** >> **[Information]** option on the device webpage. The following information will be provided:

Device information (model, software and hardware version) and Internet Information etc.

10.2 Reboot Device

User can restart the device through the webpage, click **[System]** >> **[Reboot Phone]** and click **[Reboot]** button, or directly unplug the power to restart the device.

When the device has problems and user can't access the web page, you can disassemble the surface shell and press the "**RESET**" button. The device will restart and the configuration will not change.

10.3 Device Factory Reset

Restoring the factory settings will delete all configurations, database and configuration files on the device and the device will be restored to factory default state.

To restore the factory settings, please go to **[System]** >> **[Configuration]** >> **[Reset Phone]** page, and click **[Reset]** button, the device will return to the factory default state.

10.4 Network Packets Capture

In order to obtain the data packet of the device, the user needs to log in to the webpage of the device, open the webpage **[System]** >> **[Tools]**, and click the **[Start]** option in the "Network Packets Capture". A message will pop up asking the user to save the captured file. At this time, the user can perform related operations, such as starting/deactivating the line or making a call, and clicking the **[Stop]** button on the webpage after completion. Network packets during the device are saved in a file. Users can analyze the packet or send it to the Fanvil Technical Support mailbox.

10.5 Get Device Log

Log information is helpful when encountering abnormal problems. In order to obtain the log information of the device, the user can log on to the device web page, open the web page [device log], click the "start" button, follow the steps of the problem until the problem appears, and then click the "end" button, "save" to the local for analysis or send the log to the technician to locate the problem.

10.6 Common Trouble Cases

Table 25 - Trouble Cases

Trouble Case	Solution
Device could not boot up	<ol style="list-style-type: none"> 1. The device is powered by external power supply via power adapter or POE switch. Please use standard power adapter provided or POE switch met with the specification requirements and check if device is well connected to power source. 2. If the device enters "POST mode" (Solid orange), the device system is damaged. Please contact your location technical support to help you restore your equipment system.
Device could not register to a service provider	<ol style="list-style-type: none"> 1. Please check if the device is connected to the network. 2. If the network connection is good, please check your line configuration again. If all configurations are correct, contact your service provider for support, or follow the instructions in "10.4 Network Data Capture" to obtain a registered network packet and send it to the Fanvil Support Email to help analyze the issue.