



YLI ELECTRONIC

Single Door Explosion-proof Magnetic Lock Instructions



Model: YM-280N-EX

Product Overview

The explosion-proof electromagnetic lock produced by YLI are designed and manufactured in accordance with the relevant provisions of EU regulations 2014/34/EU. The products have been certified by EU ATEX explosion-proof testing institution

Please read the following information carefully before using our products to ensure that you can use them correctly and avoid safety accidents caused by improper use and operation.

Specification

- Lock body dimension: 250Lx48.8Wx26.4H(mm)
- Armature plate dimension: 180Lx38.8Wx13H(mm)
- Holding force: 280kg(600Lbs)±10%
- Input voltage: DC12V±10%(Customizable 24VDC)
- Current: DC12V/550mA±10%
DC24V/275mA±10%(Customizable)
- Maximum power consumption: 6.6W
- Signal output: Lock signal contacts
(Customizable door signal contacts)
- Lead length: 3m (GB fireproof cable)
- Certificate numbe:ECM 22 ATEX-B Cd66
- ATEX: II 1G Ex ib IIC T6 Gb
II 2D Ex ib IIIC T85°C /T100°C Db
- International certification: CE,MA,ISO9001,UL,LVD,FCC
- Protection Grade: IP66
- Surface temperature: ≤ Ambient temperature +20°C
- Applicable temperature: -30°C ~+50°C (-22~122F)
- Applicable door types: wooden door,glass door, metal door,
fire door, cleanroom door
- Weight: 2.3kg

Diagram (unit:mm)

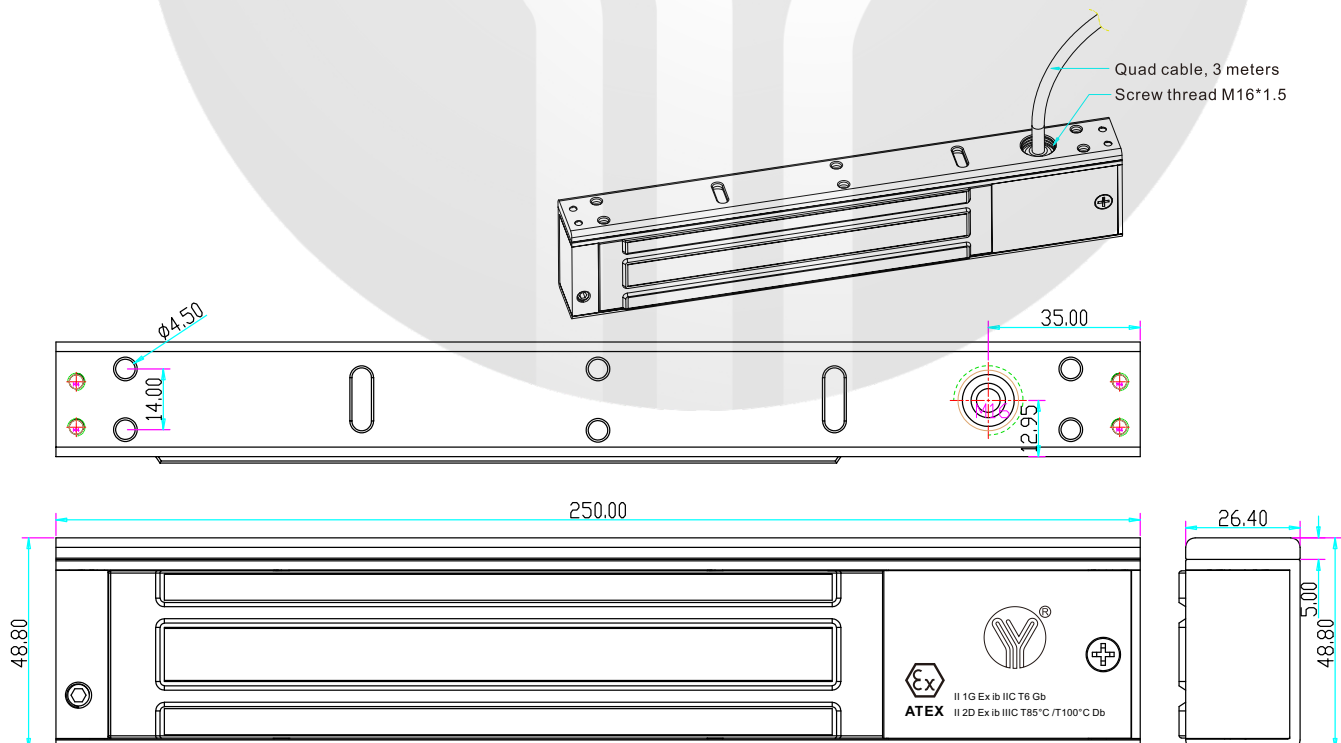

Installation

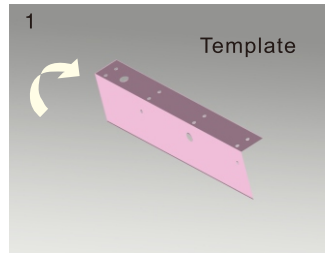
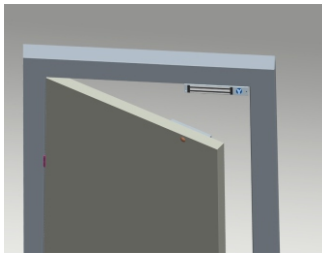

1 Fold the plate to 90°

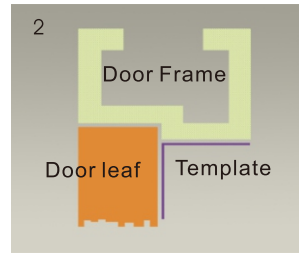

2 Close the door first, then place the upper side of template on door frame, while adjust the left side next to the door leaf.

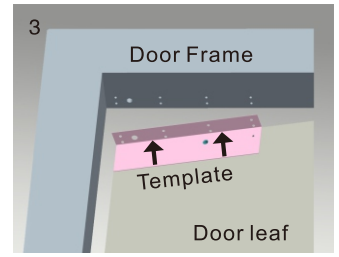

3 Mark screw positions of armature plate and magnetic lock on door leaf and door frame respectively.

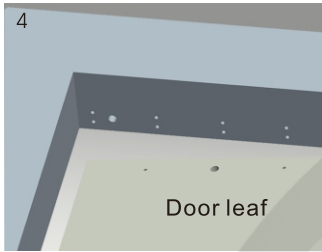

4 Drill holes based on the marked positions.

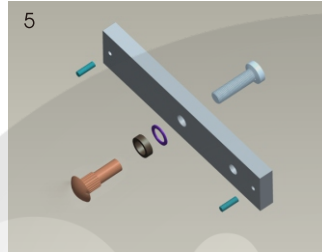

5 Make a combination based on the picture.

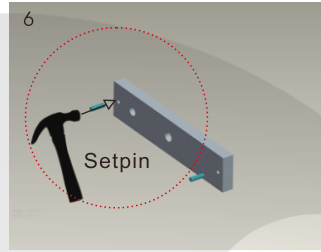

6 Strike the pin into the armature plate slightly (to avoid movement).

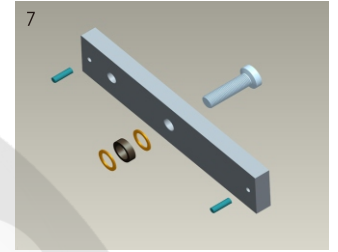

7 Make a combination based on the picture (add washer accordingly). The rubber ring must be added.

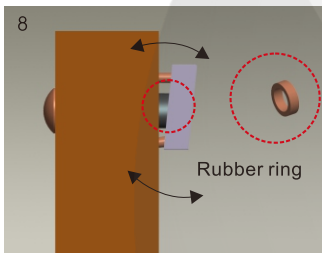

8 Place the rubber ring between armature plate and door leaf.

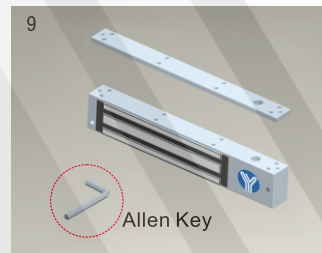

9 Use Allen key to remove the mounting plate from lock body.

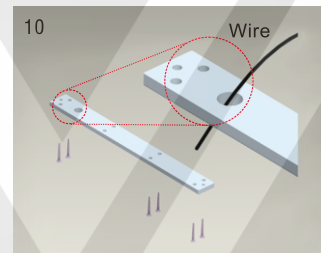

10 Fix the mounting plate on the door frame according to the holes drilled earlier.

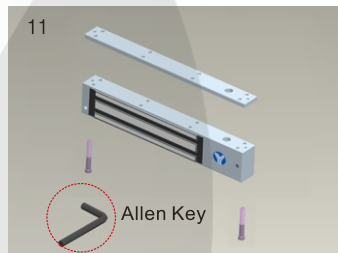

11 Use Allen key to screw the lock body on the mounting plate.

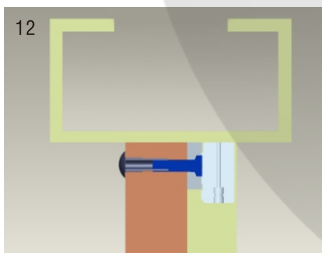

12 Close the door to test holding force. The angle between armature plate and magnetic lock can be adjusted by adding or reducing washers.

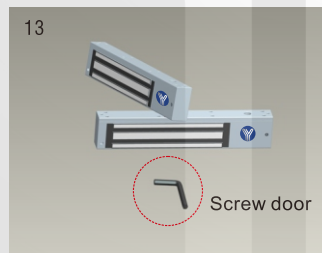

13 After all the appropriate procedures, the holding force can be maximized. Finally, fix the tamper screw.

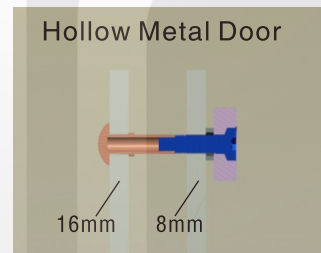

Hollow Metal Door

Drill a hole
Inside: Diameter is 8mm
Outside: Diameter is 16mm

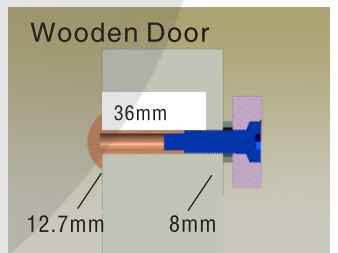

Wooden Door

Drill a hole
Inside: Diameter is 8mm
Outside: Diameter is 12.7mm

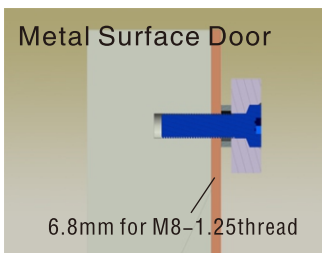

Metal Surface Door

6.8mm for M8-1.25thread

Inside: Drill a hole diameter is 8mm folding the plastic straight pin

⚠ Notice:

Thickness of Door Leaf:

350LBS: 44mm 600LBS: 50mm 800LBS: 48mm 1200LBS: 46mm

- A. The screw of armature plate should not be fixed too tight. Proper elasticity should be guaranteed for the rubber ring so that the armature plate can adjust itself to the appropriate position.
- B. Check the jumper's position before connecting. Figure out it represents 12VDC or 24VDC.

Different brackets are available according to different types of doors. For example, narrow door , frameless glass door and inward opening door.

L Bracket

When the door frame thickness is less than 42mm, L bracket is needed.

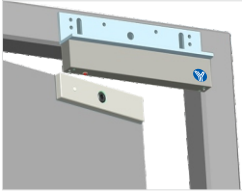

Single Door Magnetic Lock Bracket

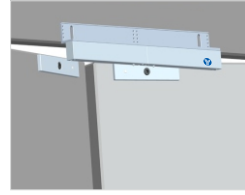

Double Door Magnetic Lock Bracket

LC Bracket

LC Bracket one-piece design, wires are mortised, no damage on wires



Single Door Magnetic Lock Bracket



Double Door Magnetic Lock Bracket

ZL Bracket

If install a bracket on inward opening door, ZL bracket is needed

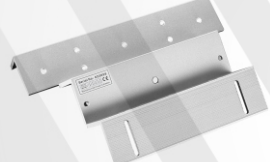
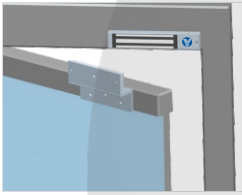

Single Door Magnetic Lock Bracket

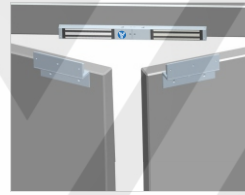

Double Door Magnetic Lock Bracket

ZLC Bracket

Hidden-line Design of bracket for single door magnetic lock, one-piece design, durable, easy installation



Single Door Magnetic Lock Bracket

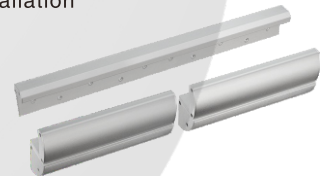
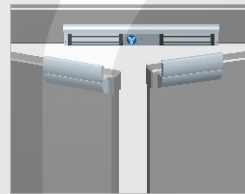

Double Door Magnetic Lock Bracket

GZ Bracket

One-piece design, durable & professional design, easy installation, suitable for 10-15mm frameless glass door

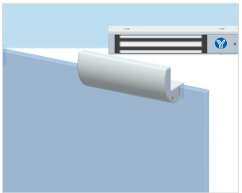

Single Door Magnetic Lock Bracket

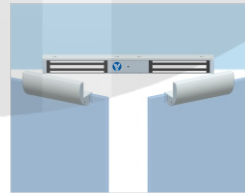

Double Door Magnetic Lock Bracket

U Bracket

If door leaf is glass, need U bracket to be used with lock (suitable for 10-12mm glass door)

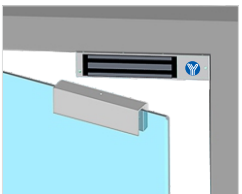

Single Door Magnetic Lock Bracket

Installation of Armature Plate

If door leaf is too thick, need to choose I bracket

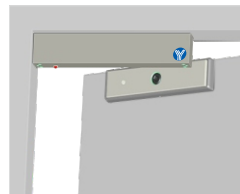

Double Door Magnetic Lock Bracket

Anti-residual Magnetism Design

Professional anti-residual magnetism design, no residual magnetism when power off. It still unlocks quickly after 500,000 times aging test.

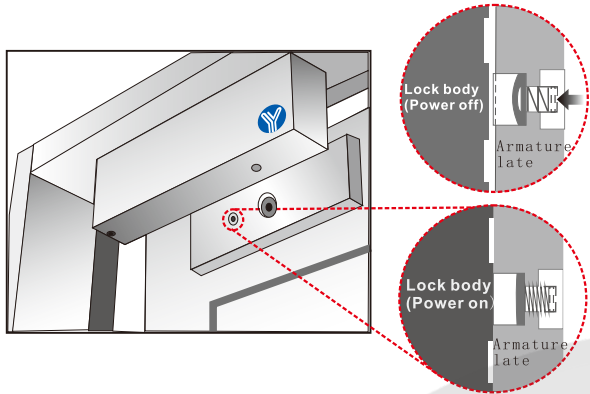

Wiring Indication

A、12VDC(Factroy default)

B、24V DC(Customizable)

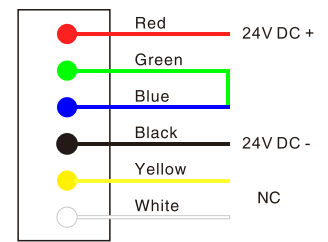
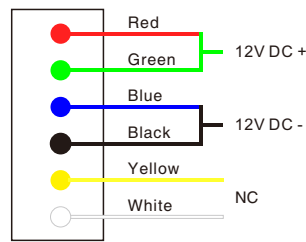

Product Safety Precautions

1. Do not install it with power on to avoid dangerous situation
2. A dedicated power supply for the access control system with a rated voltage of at least 12V or 24V and a rated current of at least 1000mA should be installed at the power supply end of the product.
3. The connection mode of the product is permanent cable leading-in connection mode. Appropriate measures should be taken to connect the free end of the cable, and the cable must have a protective device to prevent mechanical damage.
4. When used in combustible dust environment, effective measures should be taken to clean the product shell to avoid dust accumulation, but the use of compressed air purging products is strictly prohibited.
5. The user shall not replace the parts of the product by himself, and shall work with the manufacturer to solve the problem in case of product failure, so as to prevent the occurrence of damage.

Production Process

The production of explosion-proof magnetic locks is strictly implemented according to the standardized SOP and quality inspection standards to ensure that the products meet the high quality requirements

Automatic Potting Machine



Sealed with fire retardant resin in accordance with EU and American Standards

Functional Test

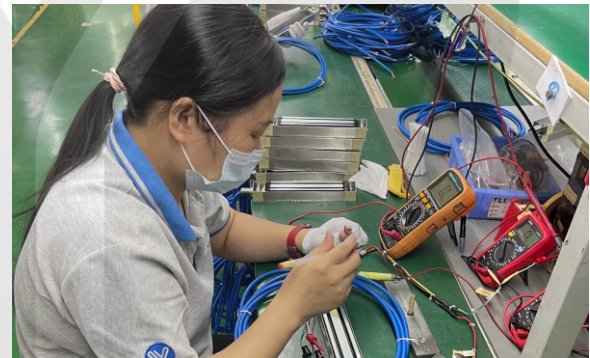

Ensure that the performance of each product is qualified.

Aging Test



Strictly implement of inspection to ensure high quality, reliability and safety

Holding Force Test



The holding force is an important performance index of magnetic lock